

PHILIPS

Professional
Display Solutions

X Line

55BDL4005X
55BDL4007X



www.philips.com/welcome
User Manual (English)

Safety Instructions

Safety precautions and maintenance



WARNING: Use of controls, adjustments or procedures other than those specified in this documentation may result in exposure to shock, electrical hazards and/or mechanical hazards.

Read and follow these instructions when connecting and using your display:

Operation:

- Keep the display out of direct sunlight and away from stoves or any other heat sources.
- Keep the display away from oil, otherwise the plastic cover may be damaged.
- It is recommended to set the display up in the well-ventilated place.
- Ultra-violet ray filter is necessary of outdoor operation.
- If the product will be used in extreme conditions such as high temperature, humidity, display patterns or operation time etc... It is strongly recommended to contact Philips for Application engineering advice. Otherwise, its reliability and function may not be guaranteed. Extreme conditions are commonly found at Airports, Transit Stations, Banks, Stock market, and Controlling systems.
- Remove any object that could fall into ventilation holes or prevent proper cooling of the display's electronics.
- Do not block the ventilation holes on the cabinet.
- When positioning the display, make sure the power plug and outlet are easily accessible.
- When turning off the display by detaching the power cord, wait 6 seconds before re-attaching the power cord for normal operation.
- Ensure the use of an approved power cord provided by Philips at all times. If your power cord is missing, please contact your local service center.
- Do not subject the display to severe vibration or high impact conditions during operation.
- Do not knock or drop the display during operation or transportation.
- The eye bolt is for usage in short-time maintenance and installation. We suggest not to use the eye bolt for more than 1 hour. Prolong usage is prohibited. Please keep a clear safety area under the display while using the eye bolt.

Maintenance:

- To protect your display from possible damage, do not put excessive pressure on the LCD panel. When moving your display, grasp the frame to lift; do not lift the display by placing your hand or fingers on the LCD panel.
- Unplug the display if you are not going to use it for an extensive period of time.
- Unplug the display if you need to clean it with a slightly damp cloth. The screen may be wiped with a dry cloth when the power is off. However, never use organic solvent, such as, alcohol, or ammonia-based liquids to clean your display.
- To avoid the risk of shock or permanent damage to the set, do not expose the display to dust, rain, water or an excessively moist environment.
- If your display becomes wet, wipe it with dry cloth as soon as possible.
- If a foreign substance or water gets in your display, turn the power off immediately and disconnect the power cord. Then remove the foreign substance or water, and send the unit to the maintenance center.
- Do not store or use the display in locations exposed to heat, direct sunlight or extreme cold.
- In order to maintain the best performance of your display and ensure a longer lifetime, we strongly recommend using the display in a location that falls within the following temperature and humidity ranges.

Environmental absolute ratings

| Item | Min. | Max. | Unit |
|---------------------------------------|------|------|------|
| Storage temperature | -20 | 65 | °C |
| Operation temperature | 0 | 40 | °C |
| Glass Surface temperature (Operation) | 0 | 65 | °C |
| Storage humidity | 5 | 90 | % RH |
| Operating humidity | 20 | 80 | % RH |

- LCD panel temperature need to be 25 degrees Celsius at all time for better luminance performance.

- Only the lifetime of the display stated in this specification is guaranteed if the display is used under the proper operation conditions.

IMPORTANT: Always activate a moving screen saver program when you leave your display unattended. Always activate a periodic screen refresh application if the unit will display unchanging static content. Uninterrupted display of still or static images over an extended period may cause “burn in”, also known as “after-imaging” or “ghost imaging”, on your screen. This is a well-known phenomenon in LCD panel technology. In most cases, the “burned in” or “after-imaging” or “ghost imaging” will disappear gradually over a period of time after the power has been switched off.

WARNING: Severe “burn-in” or “after-image” or “ghost image” symptoms will not disappear and cannot be repaired. This is also not covered under the terms of your warranty.

Service:

- The casing cover should be opened only by qualified service personnel.
- If there is any need for repair or integration, please contact your local service center.
- Do not leave your display under direct sunlight.



If your display does not operate normally, having followed the instructions set out in this document, please contact a technician or your local service center.

Stability Hazard.

The device may fall, causing serious personal injury or death. To prevent injury, this device must be securely attached to the floor/wall in accordance with the installation instructions.

Read and follow these instructions when connecting and using your display:



- Unplug the display if you are not going to use it for an extensive period of time.
- Unplug the display if you need to clean it with a slightly damp cloth. The screen may be wiped with a dry cloth when the power is off. However, never use alcohol, solvents or ammonia-based liquids.
- Consult a service technician if the display does not operate normally when you have followed the instructions in this manual.
- The casing cover should be opened only by qualified service personnel.
- Keep the display out of direct sunlight and away from stoves or any other heat sources.
- Remove any object that could fall into the vents or prevent proper cooling of the display’s electronics.
- Do not block the ventilation holes on the cabinet.
- Keep the display dry. To avoid electric shock, do not expose it to rain or excessive moisture.
- When turning off the display by detaching the power cable or DC power cord, wait for 6 seconds before re-attaching the power cable or DC power cord for normal operation..
- To avoid the risk of shock or permanent damage to the set do not expose the display to rain or excessive moisture.
- When positioning the display, make sure the power plug and outlet are easily accessible.
- **IMPORTANT:** Always activate a screen saver program during your application. If a still image in high contrast remains on the screen for an extended period of time, it may leave an ‘after-image’ or ‘ghost image’ on the front of the screen. This is a well-known phenomenon that is caused by the shortcomings inherent in LCD technology. In most cases the afterimage will disappear gradually over a period of time after the power has been switched off. Be aware that the after-image symptom cannot be repaired and is not covered under warranty.
- If provided with a 3-pin attachment plug on the power cord, plug the cord into a grounded (earthed) 3-pin outlet. Do not disable the power cord grounding pin, for example, by attaching a 2-pin adapter. The grounding pin is an important safety feature.

EU Declaration of Conformity

This device complies with the requirements set out in the Council Directive on the Approximation of the Laws of the Member States relating to Electromagnetic Compatibility (2014/30/EU), Low-voltage Directive (2014/35/EU), RoHS directive (2011/65/EU).2009/125/EC(Erp directive).

This product has been tested and found to comply with the harmonized standards for Information Technology Equipment, these harmonized standards published under Directives of Official Journal of the European Union.

ESD Warnings

When user close to the monitor may cause the equipment discharge and reboot to the display of main menu.

Warning:

This equipment is compliant with Class A of EN55032/CISPR 32. In a residential environment this equipment may cause radio interference.

Federal Communications Commission (FCC) Notice (U.S. Only)



NOTE: This equipment has been tested and found to comply with the limits for a Class A digital device, pursuant to part 15 of the FCC Rules. These limits are designed to provide reasonable protection against harmful interference when the equipment is operated in a commercial environment. This equipment generates, uses, and can radiate radio frequency energy and, if not installed and used in accordance with the instruction manual, may cause harmful interference to radio communications. Operation of this equipment in a residential area is likely to cause harmful interference in which case the user will be required to correct the interference at his own expense.



Changes or modifications not expressly approved by the party responsible for compliance could void the user's authority to operate the equipment.

Use only an RF shielded cable that was supplied with the display when connecting this display to a computer device. To prevent damage which may result in fire or shock hazard, do not expose this appliance to rain or excessive moisture.

This device complies with Part 15 of the FCC Rules. Operation is subject to the following two conditions: (1) This device may not cause harmful interference, and (2) this device must accept any interference received, including interference that may cause undesired operation.

Envision Peripherals Inc.
490 N McCarthy Blvd, Suite #120
Milpitas, CA 95035
USA

Polish Center for Testing and Certification Notice

The equipment should draw power from a socket with an attached protection circuit (a three-prong socket). All equipment that works together (computer, display, printer, and so on) should have the same power supply source.

The phasing conductor of the room's electrical installation should have a reserve short-circuit protection device in the form of a fuse with a nominal value no larger than 16 amperes (A).

To completely switch off the equipment, the power supply cable must be removed from the power supply socket, which should be located near the equipment and easily accessible.

A protection mark "B" confirms that the equipment is in compliance with the protection usage requirements of standards PN-93/T-42107 and PN-89/E-06251.

Wymagania Polskiego Centrum Badań i Certyfikacji

Urządzenie powinno być zasilane z gniazda z przyłączonym obwodem ochronnym (gniazdo z kolkiem). Współpracujące ze sobą urządzenia (komputer, monitor, drukarka) powinny być zasilane z tego samego źródła.

Instalacja elektryczna pomieszczenia powinna zawierać w przewodzie fazowym rezerwową ochronę przed zwarciami, w postaci bezpiecznika o wartości znamionowej nie większej niż 16A (amperów).

W celu całkowitego wyłączenia urządzenia z sieci zasilania, należy wyjąć wtyczkę kabla zasilającego z gniazdka, które powinno znajdować się w pobliżu urządzenia i być łatwo dostępne.

Znak bezpieczeństwa "B" potwierdza zgodność urządzenia z wymaganiami bezpieczeństwa użytkownika zawartymi w PN-93/T-42107 i PN-89/E-06251.

Pozostałe instrukcje bezpieczeństwa

- Nie należy używać wtyczek adapterowych lub usuwać kolka obwodu ochronnego z wtyczki. Jeżeli konieczne jest użycie przedłużacza to należy użyć przedłużacza 3-żyłowego z prawidłowo połączonym przewodem ochronnym.
- System komputerowy należy zabezpieczyć przed nagłymi, chwilowymi wzrostami lub spadkami napięcia, używając eliminatora przepięć, urządzenia dopasowującego lub bezzakłócenowego źródła zasilania.
- Należy upewnić się, aby nic nie leżało na kablach systemu komputerowego, oraz aby kable nie były umieszczone w miejscu, gdzie można byłoby na nie nadeptywać lub potykać się o nie.
- Nie należy rozlewać napojów ani innych płynów na system komputerowy.
- Nie należy wpychać żadnych przedmiotów do otworów systemu komputerowego, gdyż może to spowodować pożar lub porażenie prądem, poprzez zwarcie elementów wewnętrznych.
- System komputerowy powinien znajdować się z dala od grzejników i źródeł ciepła. Ponadto, nie należy blokować otworów wentylacyjnych. Należy unikać kładzenia luźnych papierów pod komputer oraz umieszczania komputera w ciasnym miejscu bez możliwości cyrkulacji powietrza wokół niego.

Electric, Magnetic and Electromagnetic Fields ("EMF")

1. We manufacture and sell many products targeted at consumers, which, like any electronic apparatus, in general have the ability to emit and receive electromagnetic signals.
2. One of our leading Business Principles is to take all necessary health and safety measures for our products, to comply with all applicable legal requirements and to stay well within the EMF standards applicable at the time of producing the products.
3. We are committed to develop, produce and market products that cause no adverse health effects.
4. We confirm that if its products are handled properly for their intended use, they are safe to use according to scientific evidence available today.
5. We play an active role in the development of international EMF and safety standards, enabling us to anticipate further developments in standardization for early integration in its products.

Information for U.K. only

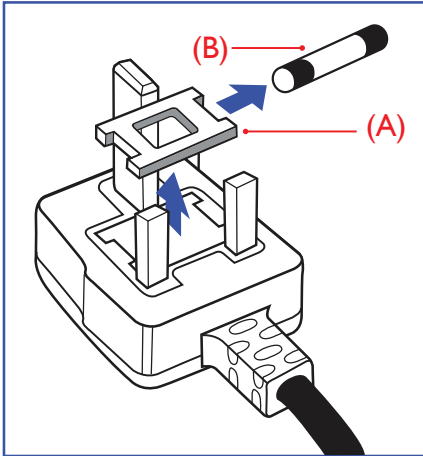

WARNING - THIS APPLIANCE MUST BE EARTHED.

Important:

This apparatus is supplied with an approved moulded 13A plug. To change a fuse in this type of plug proceed as follows:+

1. Remove fuse cover and fuse.
2. Fit new fuse which should be a BS 1362 5A, A.S.T.A. or BSI approved type.
3. Refit the fuse cover.

If the fitted plug is not suitable for your socket outlets, it should be cut off and an appropriate 3-pin plug fitted in its place.

If the mains plug contains a fuse, this should have a value of 5A. If a plug without a fuse is used, the fuse at the distribution board should not be greater than 5A.

Note: The severed plug must be destroyed to avoid a possible shock hazard should it be inserted into a 13A socket elsewhere.

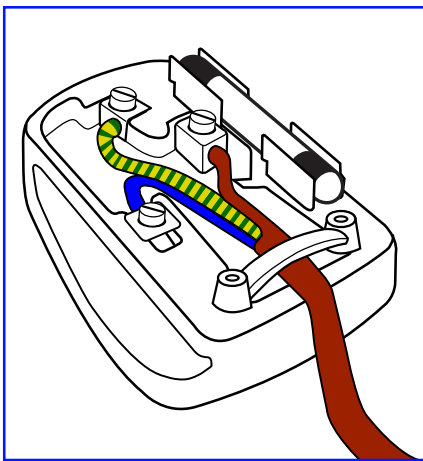

How to connect a plug

The wires in the mains lead are coloured in accordance with the following code:

BLUE - "NEUTRAL" ("N")

BROWN - "LIVE" ("L")

GREEN & YELLOW - "EARTH" ("E")

1. The GREEN & YELLOW wire must be connected to the terminal in the plug which is marked with the letter "E" or by the Earth symbol or coloured GREEN or GREEN & YELLOW.
2. The BLUE wire must be connected to the terminal which is marked with the letter "N" or coloured BLACK.
3. The BROWN wire must be connected to the terminal which marked with the letter "L" or coloured RED.

Before replacing the plug cover, make certain that the cord grip is clamped over the sheath of the lead - not simply over the three wires.

North Europe (Nordic Countries) Information

Placering/Ventilation

VARNING:

FÖRSÄKRA DIG OM ATT HUVUDBRYTARE OCH UTTAG ÄR LÄTÅTKOMLIGA, NÄR DU STÄLLER DIN UTRUSTNING PÅ PLATS.

Placering/Ventilation

ADVARSEL:

SØRG VED PLACERINGSFOR, AT NETLEDNINGENS STIK OG STIKKONTAKT ER NEMT TILGÆNGLIGE.

Paikka/Ilmankierto

VAROITUS:

SIVOITA LAITE SITEN, ETTÄ VERKKOJOHTO VOIDAAN TARVITTAESSA HELPOSTI IRROTTAA PISTORASIESTA.

Plassering/Ventilasjon

ADVARSEL:

NÅR DETTE UTSTYRET PLASSERES, MÅ DU PASSE PÅ AT KONTAKTENE FOR STØMTILFØRSEL ER LETTE Å NÅ.

China RoHS

根据中国大陆《电器电子产品有害物质限制使用管理办法》，以下部分列出了本产品中可能包含的有害物质的名称和含量。

| 部件名称 | 有害物质 | | | | | |
|---------|-----------|-----------|-----------|------------------|---------------|-----------------|
| | 铅 (Pb) | 汞 (Hg) | 镉 (Cd) | 六价铬 (Cr (VI)) | 多溴联苯 (PBB) | 多溴二苯醚 (PBDE) |
| 外壳 | ○ | ○ | ○ | ○ | ○ | ○ |
| 液晶显示屏 | × | ○ | ○ | ○ | ○ | ○ |
| 电路板组件* | × | ○ | ○ | ○ | ○ | ○ |
| 电源适配器 | × | ○ | ○ | ○ | ○ | ○ |
| 电源线/连接线 | × | ○ | ○ | ○ | ○ | ○ |
| 遥控器 | X | ○ | ○ | ○ | ○ | ○ |

本表格依据SJ/T 11364 的规定编制。

*: 电路板组件包括印刷电路板及其构成的零部件，如电阻、电容、集成电路、连接器等。

○: 表示该有害物质在该部件所有均质材料中的含量均在 GB/T 26572规定的限量要求以下。

X: 表示该有害物质至少在该部件的某一均质材料中的含量超出GB/T 26572规定的限量要求。

上表中打“×”的部件，应功能需要，部分有害物质含量超出GB/T 26572规定的限量要求，但符合欧盟RoHS法规要求（属于豁免部分）。

备注：上表仅做为范例，实际标示时应依照各产品的实际部件及所含有害物质进行标示。



环保使用期限

此标识指期限（十年），电子电气产品中含有的有害物质在正常使用的条件下不会发生外泄或突变，电子电气产品用户使用该电子电气产品不会对环境造成严重污染或对其人身、财产造成严重损害的期限。

《废弃电器电子产品回收处理管理条例》提示性说明

为了更好地关爱及保护地球，当用户不再需要此产品或产品寿命终止时，请遵守国家废弃电器电子产品回收处理相关法律法规，将其交给当地具有国家认可的回收处理资质的厂商进行回收处理，不当利用或者处置可能会对环境和人类健康造成影响。

警告

此为 A 级产品。在生活环境中，该产品可能会造成无线电干扰。在这种情况下，可能需要用户对干扰采取切实可行的措施。

| 單元 | 限用物質及其化學符號 | | | | | |
|--|------------|-----------|-----------|----------------------------|---------------|-----------------|
| | 鉛 (Pb) | 汞 (Hg) | 鎘 (Cd) | 六價鉻 (Cr ⁺⁶) | 多溴聯苯 (PBB) | 多溴二苯醚 (PBDE) |
| 塑料外框 | ○ | ○ | ○ | ○ | ○ | ○ |
| 後殼 | ○ | ○ | ○ | ○ | ○ | ○ |
| 液晶面板 | — | ○ | ○ | ○ | ○ | ○ |
| 電路板組件 | — | ○ | ○ | ○ | ○ | ○ |
| 電源線 | — | ○ | ○ | ○ | ○ | ○ |
| 其他線材 | — | ○ | ○ | ○ | ○ | ○ |
| 遙控器 | — | ○ | ○ | ○ | ○ | ○ |
| 喇叭 (選配) | — | ○ | ○ | ○ | ○ | ○ |
| 風扇 (選配) | — | ○ | ○ | ○ | ○ | ○ |
| 備考1. “○” 係指該項限用物質之百分比含量未超出百分比含量基準值。 備考2. “—” 係指該項限用物質為排除項目。 | | | | | | |

警語：使用過度恐傷害視力。

注意事項：

- (1) 使用30分鐘請休息10分鐘。
- (2) 未滿2歲幼兒不看螢幕，2歲以上每天看螢幕不要超過1小時。

警告使用者：

此為甲類資訊技術設備，於居住環境中使用時，可能會造成射頻擾動，在此種情況下，使用者會被要求採取某些適當的對策。

Turkey RoHS:

Türkiye Cumhuriyeti: EEE Yönetmeliğine Uygundur

Ukraine RoHS:

Обладнання відповідає вимогам Технічного регламенту щодо обмеження використання деяких небезпечних речовин в електричному та електронному обладнанні, затвердженого постановою Кабінету Міністрів України від 3 грудня 2008 № 1057

End-of-Life Disposal

Your new Public Information Display contains materials that can be recycled and reused. Specialized companies can recycle your product to increase the amount of reusable materials and to minimize the amount to be disposed of.

Please find out about the local regulations on how to dispose of your old display from your local Philips dealer.

(For customers in Canada and U.S.A.)

This product may contain lead and/or mercury. Dispose of in accordance to local-state and federal regulations. For additional information on recycling contact www.eia.org (Consumer Education Initiative)

Waste Electrical and Electronic Equipment-WEEE

Attention users in European Union private households



This marking on the product or on its packaging illustrates that, under European Directive 2012/19/EU governing used electrical and electronic appliances, this product may not be disposed of with normal household waste. You are responsible for disposal of this equipment through a designated waste electrical and electronic equipment collection. To determine the locations for dropping off such waste electrical and electronic, contact your local government office, the waste disposal organization that serves your household or the store at which you purchased the product.

Attention users in United States:

Please dispose of according to all Local, State and Federal Laws. For the disposal or recycling information, contact: www.mygreenelectronics.com or www.eiae.org.

End of Life Directives-Recycling



Your new Public Information Display contains several materials that can be recycled for new users. Please dispose of according to all Local, State, and Federal laws.



ENERGY STAR is a program run by the U.S. Environmental Protection Agency (EPA) and U.S. Department of Energy (DOE) that promotes energy efficiency.

This product qualifies for ENERGY STAR in the “factory default” settings and this is the setting in which power savings will be achieved.

Changing the factory default picture settings or enabling other features will increase power consumption that could exceed the limits necessary to qualify for ENERGY STAR rating.

For more information on the ENERGY STAR program, refer to energystar.gov.

Restriction on Hazardous Substances statement (India)

This product complies with the “E-Waste (Management) Rules, 2016” CHAPTER V, rule 16, sub-rule (1) . Whereas New Electrical and Electronic Equipment and their components or consumables or parts or spares do not contain Lead, Mercury, Cadmium, Hexavalent Chromium, polybrominated biphenyls and polybrominated diphenyl ethers beyond a maximum concentration value of 0.1% by weight in homogenous materials for lead, mercury, hexavalent chromium, polybrominated biphenyls and polybrominated diphenyl ethers and of 0.01% by weight in homogenous materials for cadmium. except of exemptions set in Schedule 2 of the Rule.

E-Waste Declaration for India



This symbol on the product or on its packaging indicates that this product must not be disposed of with your other household waste. Instead it is your responsibility to dispose of your waste equipment by handing it over to a designated collection point for the recycling of waste electrical and electronic equipment . The separate collection and recycling of your waste equipment at the time of disposal will help to conserve natural resources and ensure that it is recycled in a manner that protects human health and the environment. For more information about E -waste please visit <http://www.india.philips.com/about/sustainability/recycling/index.page> and to know where you can drop off your waste equipment for recycling in India please contact on below given contact details.

Helpline number: 1800-425-6396 (Monday to Saturday, 9 a.m. to 5:30 pm)

E-mail: india.callcentre@tpv-tech.com

Batteries



For EU: The crossed-out wheeled bin implies that used batteries should not be put to the general household waste! There is a separate collection system for used batteries, to allow proper treatment and recycling in accordance with legislation.

Please contact your local authority for details on the collection and recycling schemes.

For Switzerland: The used battery is to be returned to the selling point.

For other non-EU countries: Please contact your local authority for correct method of disposal of the used battery.

According to EU directive 2006/66/EC, the battery can't be disposed improperly. The battery shall be separated to collect by local service.

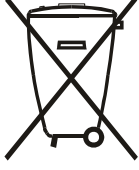

Após o uso, as pilhas e/ou baterias deverão ser entregues ao estabelecimento comercial ou rede de assistência técnica autorizada.

| | |
|-----------------------------------|--|
| Information for EAC |  |
| Month and year of manufacturing | please refer information in Rating label. |
| Name and location of manufacturer | ООО "Профтехника" Адрес: 3-й Проезд Марьиной роци, 40/1 офис 1. Москва, 127018, Россия |
| Importer and information | Наименование организации: ООО "Профтехника" Адрес: 3-й Проезд Марьиной роци, 40/1 офис 1. Москва, 127018, Россия Контактное лицо: Наталья Астафьева, +7 495 640 20 20 nat@profdisplays.ru |

Table Of Contents

| | | | | | |
|--------|---|----|--------|---|----|
| 1. | Unpacking and Installation | 1 | 4.3. | Play multimedia files via Local Area Network..... | 16 |
| 1.1. | Unpacking..... | 1 | 4.3.1. | Network settings..... | 16 |
| 1.2. | Package Contents | 1 | 4.3.2. | How to use DLNA-DMP | 16 |
| 1.3. | Installation Notes..... | 1 | 4.3.3. | How to use DLNA-DMR from PC ... | 17 |
| 1.4. | Mounting on a Wall | 2 | 4.4. | Play multimedia files from USB device | 18 |
| 1.4.1. | VESA Grid | 2 | 4.5. | Play options | 18 |
| 1.5. | Mounting in Portrait Orientation..... | 3 | 4.5.1. | Playing music files | 18 |
| 1.6. | Operating Instructions of Edge Alignment Kit | 4 | 4.5.2. | Playing movie files | 18 |
| 1.6.1. | Installing the Edge Alignment Kit.... | 4 | 4.5.3. | Playing photo files..... | 19 |
| 1.7. | Using the Edge Finishing Kit (Optional) | 5 | 4.6. | How to use Opera browser (HTML5) | 19 |
| 2. | Parts and Functions..... | 6 | 5. | Change your settings..... | 20 |
| 2.1. | Control Panel..... | 6 | 5.1. | Settings | 20 |
| 2.2. | Input/Output Terminals..... | 7 | 5.1.1. | Picture..... | 20 |
| 2.3. | Remote Control..... | 8 | 5.1.2. | Sound..... | 21 |
| 2.3.1. | General functions..... | 8 | 5.1.3. | Tiling | 21 |
| 2.3.2. | ID Remote Control | 9 | 5.1.4. | Network | 24 |
| 2.3.3. | Inserting the batteries in the remote control..... | 10 | 5.1.5. | General settings..... | 24 |
| 2.3.4. | Handling the remote control | 10 | 5.1.6. | Advanced | 27 |
| 2.3.5. | Operating range of the remote control..... | 10 | 5.1.7. | Help | 27 |
| 3. | Connecting External Equipment | 11 | 6. | USB device compatibility | 28 |
| 3.1. | Connecting External Equipment (DVD/VCR/VCD)..... | 11 | 7. | Input Mode..... | 30 |
| 3.1.1. | Using COMPONENT video input.... | 11 | 8. | Pixel Defect Policy | 31 |
| 3.1.2. | Using Video Source input | 11 | 8.1. | Pixels and Sub-Pixels | 31 |
| 3.1.3. | Using HDMI video input..... | 12 | 8.2. | Types of Pixel Defects + Dot Definition | 31 |
| 3.2. | Connecting a PC..... | 12 | 8.3. | Bright Dot Defects..... | 31 |
| 3.2.1. | Using VGA input..... | 12 | 8.4. | Dark Dot Defects | 32 |
| 3.2.2. | Using DVI input | 12 | 8.5. | Proximity of Pixel Defects..... | 32 |
| 3.2.3. | Using HDMI input | 13 | 8.6. | Pixel Defect Tolerances | 32 |
| 3.2.4. | Using DisplayPort input | 13 | 8.7. | MURA..... | 32 |
| 3.3. | Connecting Audio Equipment | 13 | 9. | Cleaning and Troubleshooting..... | 33 |
| 3.3.1. | Connecting external speakers..... | 13 | 9.1. | Cleaning | 33 |
| 3.4. | Connecting Multiple Displays in a Daisy-chain Configuration | 14 | 9.2. | Troubleshooting..... | 34 |
| 3.4.1. | Display control connection..... | 14 | 10. | Warranty Statement | 35 |
| 3.4.2. | Digital video connection..... | 14 | 11. | Technical Specifications..... | 36 |
| 3.5. | IR connection..... | 14 | | | |
| 3.6. | IR Pass-through Connection | 15 | | | |
| 3.7. | Wire-connecting to Network | 15 | | | |
| 4. | Operation | 16 | | | |
| 4.1. | Watch the Connected Video Source | 16 | | | |
| 4.2. | Change Picture Format..... | 16 | | | |

1. Unpacking and Installation

1.1. Unpacking

- This product is packed in a carton, together with the standard accessories.
- Any other optional accessories will be packed separately.
- As this product is high and heavy, the operation of moving the device is recommended to be performed by two technicians.
- After opening the carton, ensure that the contents are complete and in good condition.

1.2. Package Contents

Please verify that you received the following items with your package content:

- LCD display
- Remote control with AAA batteries
- Power cord
- DVI cable
- HDMI cable
- RS232 cable
- RS232 Daisy chain cable
- IR sensor cable
- IR cable
- Quick start guide
- Edge Alignment Kit-1: 1PCS
- Edge Alignment Kit-2: 2PCS
- Edge Alignment Pin: 2PCS
- AC Switch Cover
- Wire Clamper: 3 PCS
- Gap Mylar: 3 PCS

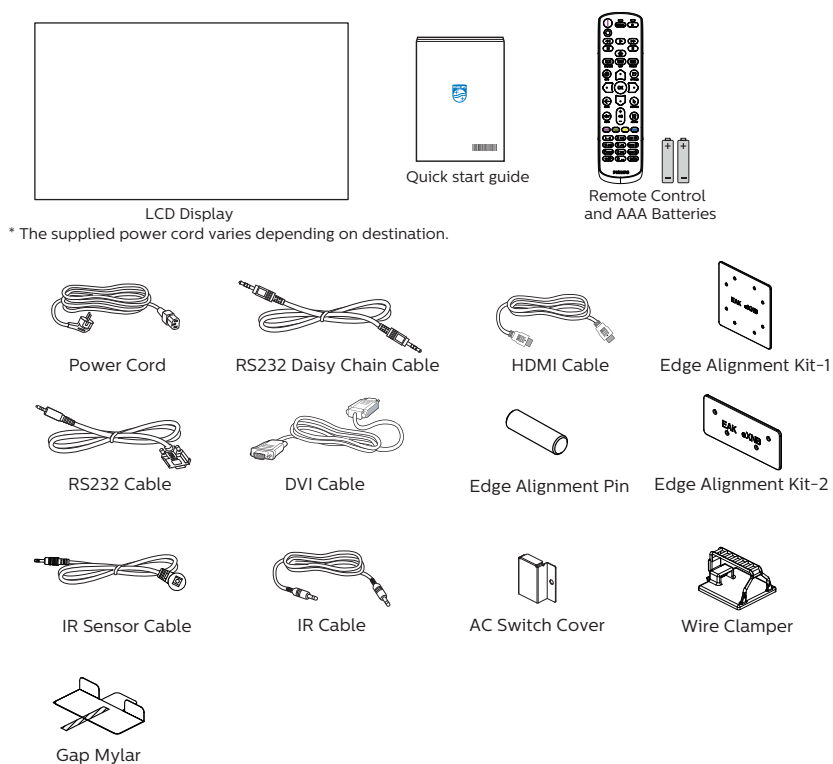

* Differences according to regions.

Display design and accessories may differ from those illustrated above.

NOTES:

- For all other regions, apply a power cord that conforms to the AC voltage of the power socket and has been approved by and complies with the safety regulations of the particular country.
- You might like to save the package box and packing material for shipping the display.

1.3. Installation Notes

- Only use the power cable provided with this product. If an extension cord is required, please consult your service agent.
- The product should be installed on a flat surface, or the product may tip over. Leave a space between the rear of the product and the wall for proper ventilation. Do not install the product in a kitchen, bathroom or a place exposed to moisture, failure to do so may shorten the life of the internal parts.
- Do not install the product where it is 3000m and higher in altitude. Failure to do so may result in malfunctions.

1.4. Mounting on a Wall

To mount this display on a wall, a standard wall-mounting kit (commercially available) is required. It is recommended that you use a mounting interface that complies with TUV-GS and /or UL1678 standard in North America.

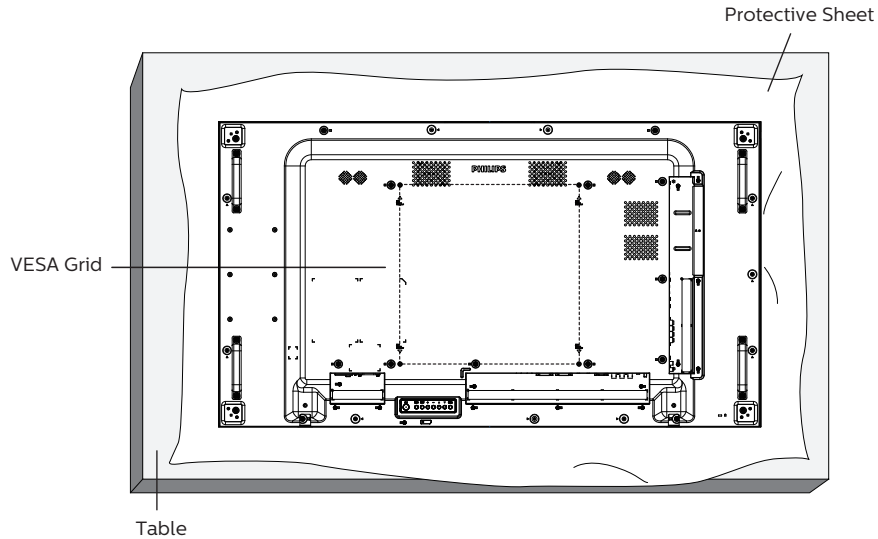

1. Spread a protective sheet which was wrapped around the display when it was packed on a flat surface. Lay the display face-down on the protective sheet to facilitate your operation without scratching the screen.
2. Ensure that you have all accessories necessary for any type of mounting (wall-mounting, ceiling mounting etc).
3. Follow the instructions that come with the base mounting kit. Failure to follow correct mounting procedures could result in damage to the equipment or injury to the user or installer. Product warranty does not cover damage caused by improper installation.
4. For the wall-mounting kit, use M6 mounting screws (with a length 10 mm longer than the thickness of the mounting bracket) and tighten them securely.

1.4.1. VESA Grid

| | |
|------------|--------------------|
| 55BDL4005X | 400(H) x 400(V) mm |
| 55BDL4007X | 400(H) x 400(V) mm |

Caution:

To prevent the display from falling:

- For wall or ceiling mounting, we recommend that you install the display with metal brackets which are commercially available. For detailed instructions about the installation, refer to the guide that come with the bracket.
- To prevent the display from falling in case of earthquake or other natural disaster, please contact the manufacturer of the bracket for the mounting location.

Required space for ventilation

Leave a space of 100 mm at the top, rear, right and left for ventilation.

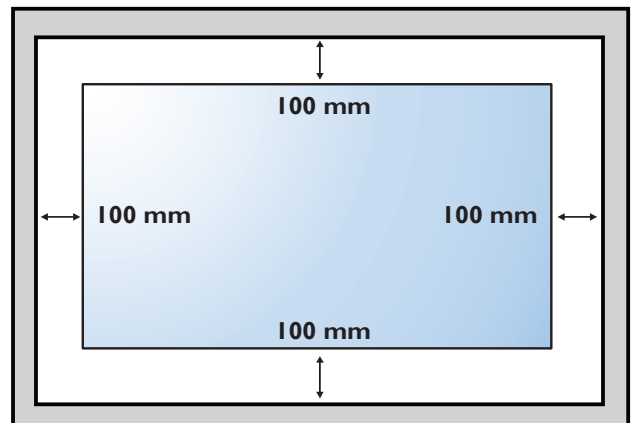

1.5. Mounting in Portrait Orientation

This display can be installed in portrait orientation.

Rotate the display 90 degrees counterclockwise based on the back view. The "PHILIPS" LOGO should be on the LEFT side when facing the backside of the display.

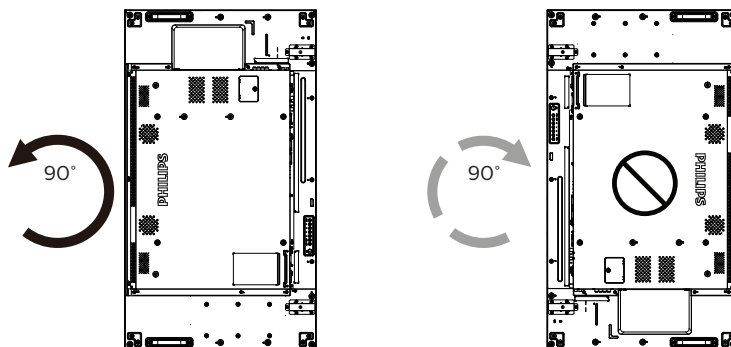

1.6. Operating Instructions of Edge Alignment Kit

1.6.1. Installing the Edge Alignment Kit

- Before installing the edge alignment kit, the display must be mounted to the frame of video wall correctly.
- We recommend you contact a professional technician when installing the edge alignment kit. We are not responsible for any damage to the product if the installation is not performed by a professional technician.
- Use the provided thumb screw for an easy installation of the edge alignment kit.
- Use the “Edge Alignment Kit-1” for four adjacent displays.

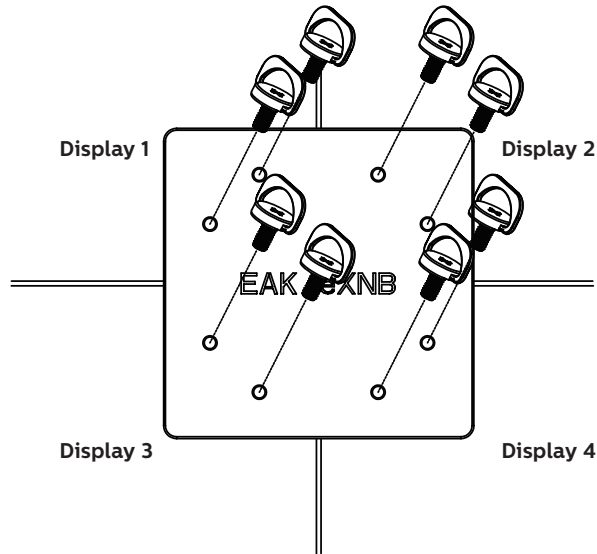

- Use the “Edge Alignment Kit-2” for two adjacent displays.

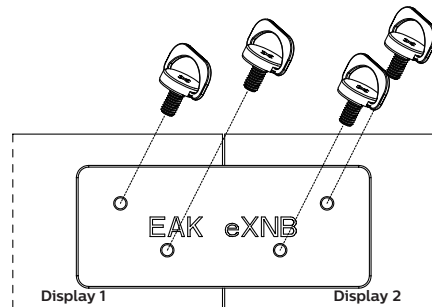

Note: When installing the edge alignment kit, please consult a professional technician for proper installation. We accept no liability for installations not performed by a professional technician.

1.7. Using the Edge Finishing Kit (Optional)

You could use the edge finishing kit to protect the display and have a better appearance.

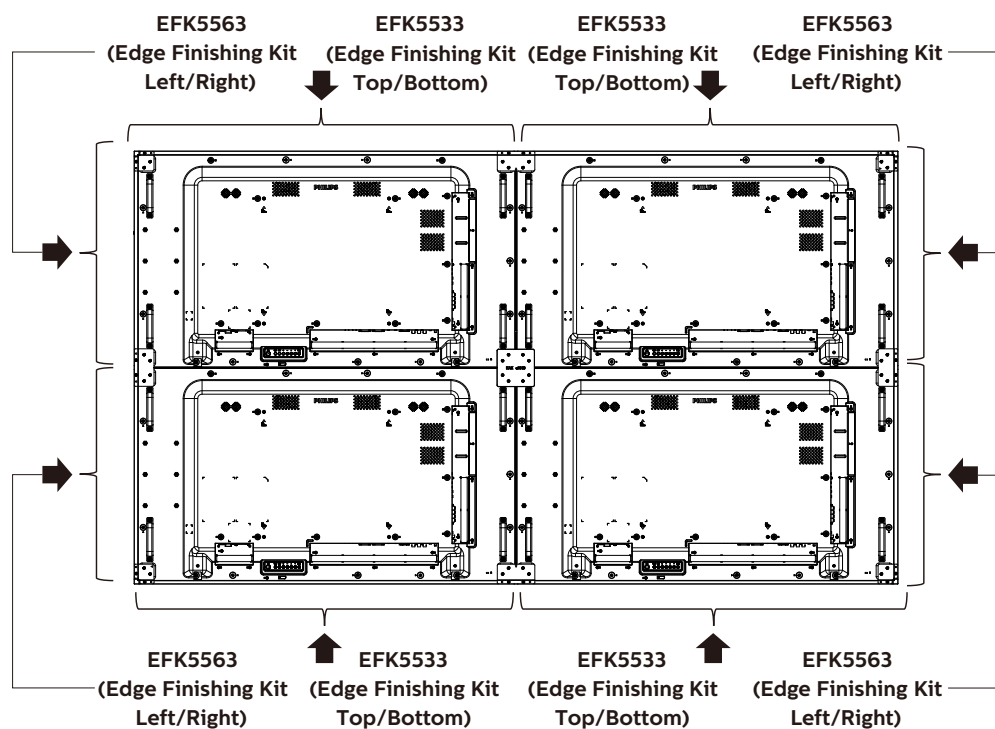

* For more detail information, please check the instruction guide in the package of kit

2. Parts and Functions

2.1. Control Panel

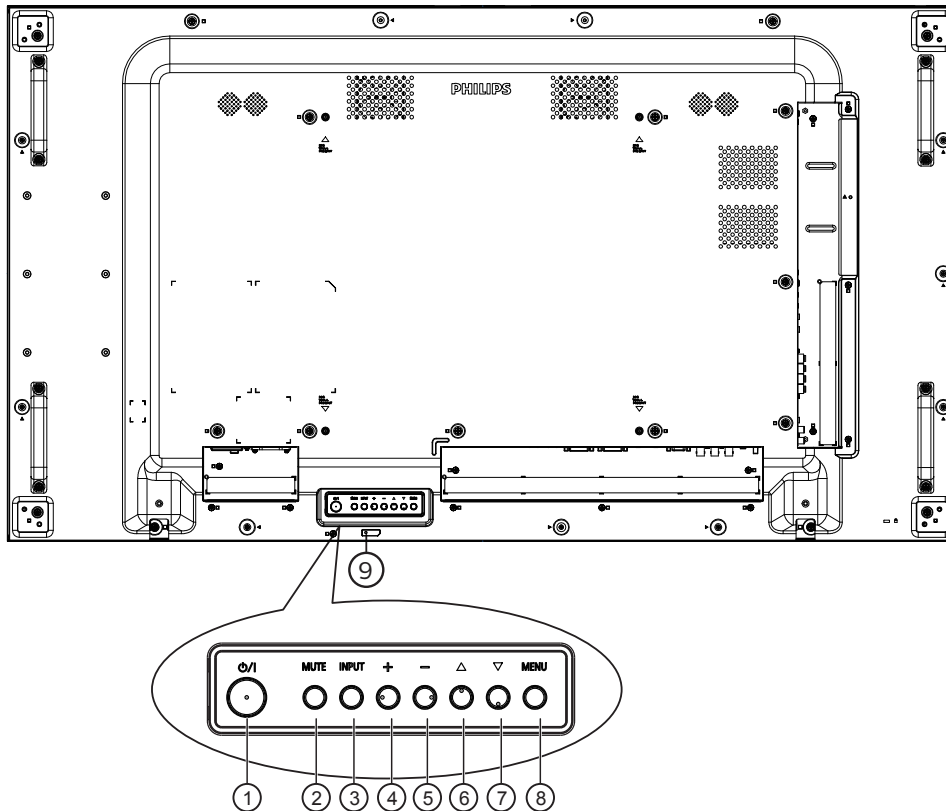

① [Power] button

Press this button to turn the display On or turn the display to standby mode.

② [MUTE] button

Press this button to mute the sound or reactivate sound.

③ [INPUT] button

Choose the input source.

Confirm a selection in the OSD menu.

④ [+] button

Increase the adjustment while OSD menu is on, or increase the audio output level while OSD menu is off.

⑤ [-] button

Decrease the adjustment while OSD menu is on, or decrease the audio output level while OSD menu is off.

⑥ [▲] button

Move the selected item one level up while the OSD menu is On.

⑦ [▼] button

Move the selected item one level down while the OSD menu is On.

⑧ [MENU] button

Return to the previous menu while the OSD menu is On. This button can also be used to activate the OSD menu when the OSD menu is Off.

⑨ Remote control sensor and power status indicator

- Receives command signals from the remote control.
- Indicates the operating status of the display:
 - Lights green when the display is turned on
 - Lights red when the display is in standby mode
 - Lights amber when the display enters APM mode
 - When {SCHEDULE} is enabled, the light blinks green and red
 - If the light blinks red, it indicates that a failure has been detected
 - Lights off when the main power of the display is turned off

2.2. Input/Output Terminals

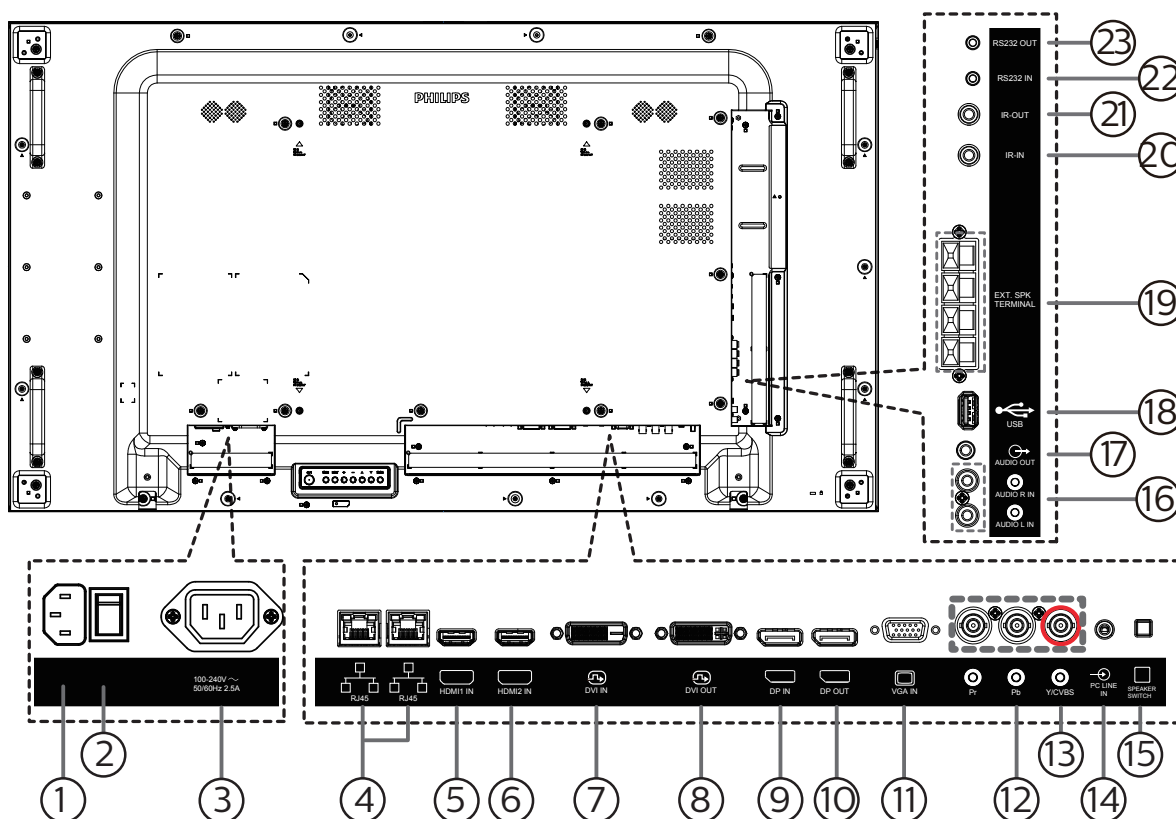

- ① **AC IN**
AC power input from the wall outlet.
- ② **MAIN POWER SWITCH**
Switch the main power between On and Off.
- ③ **AC OUT**
AC power supply to the AC IN jack of a media player.
- ④ **RJ-45 IN/OUT**
LAN control function for the use of remote control signal from control center.
- ⑤ **HDMI1 IN** / ⑥ **HDMI2 IN**
HDMI video/audio input.
- ⑦ **DVI IN**
DVI-D video input.
- ⑧ **DVI OUT**
DVI or VGA video output.
- ⑨ **DisplayPort IN** ⑩ **DisplayPort OUT**
DisplayPort video input / output.
- ⑪ **VGA IN (D-Sub)**
VGA video input.
- ⑫ **COMPONENT IN (BNC)**
Component YPbPr video source input.
- ⑬ **Y/CVBS**
Video source input.
- ⑭ **PC LINE IN**
Audio input for VGA source (3.5mm stereo phone).
- ⑮ **SPEAKER SWITCH**
Internal speaker on/off switch.
- ⑯ **AUDIO IN**
Audio input from external AV device (RCA).
- ⑰ **AUDIO OUT**
Audio output to external AV device.
- ⑱ **USB PORT**
Connect your USB storage device.
- ⑲ **SPEAKERS OUT**
Audio output to external speakers.
- ⑳ **IR IN** / ㉑ **IR OUT**
IR signal input / output for the loop-through function.
- NOTES:**
- This display's remote control sensor will stop working if the jack [IR IN] is connected.
 - To remotely control your A/V device via this display, refer to page 15 for IR Pass Through connection.
- ㉒ **RS232 IN** / ㉓ **RS232 OUT**
RS232 network input / output for the loop-through function.

2.3. Remote Control

2.3.1. General functions

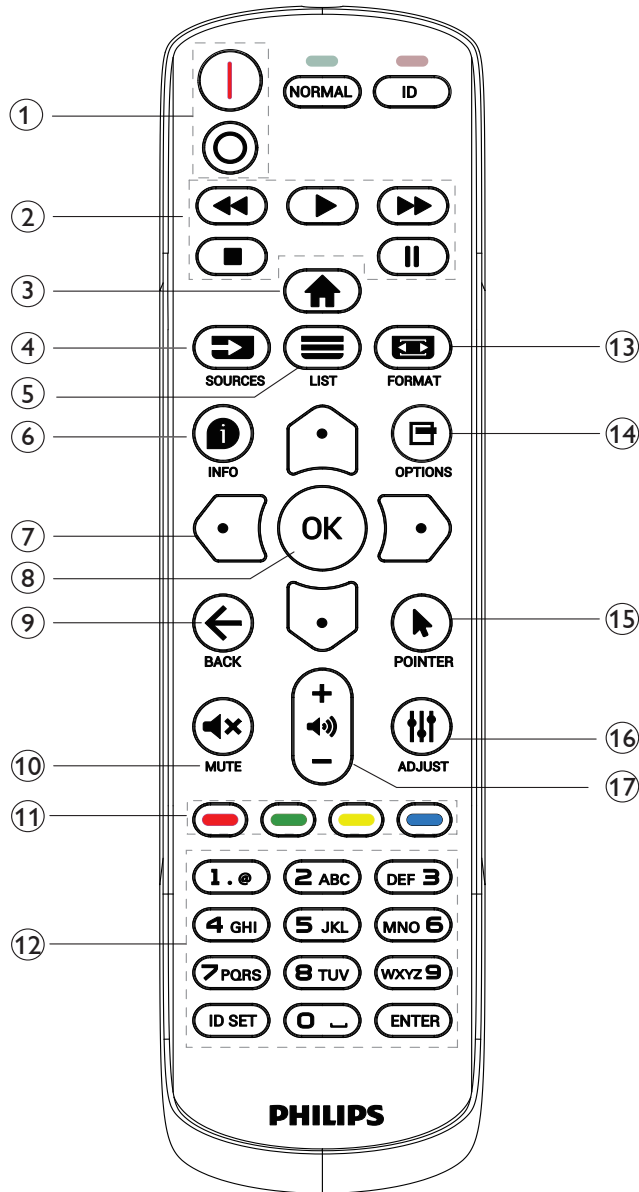

⑥ [●] INFO button

Display information about current activity

⑦ [⏪][⏩][⏮][⏭] NAVIGATION buttons

Navigate through menus and choose items..

⑧ [OK] button

Confirm an entry or selection.

⑨ [←] BACK button

Return to the previous menu page or exit from the previous function.

⑩ [🔇] MUTE button

Press to turn the mute function on/off.

⑪ [🔴] [🟢] [🟡] [🟠] COLOR buttons

Choose tasks or options

⑫ [NUMERIC] buttons

Enter text for network setting, and set up ID for ID mode

⑬ [🔍] FORMAT button

Change zoom mode.

⑭ [☰] OPTIONS button

Access currently available options, picture and sound menus.

⑮ [🖱️] POINTER button

Mouse function for Android

⑯ [🔊] ADJUST button

Access currently available options, picture and sound menus.

⑰ [−] [+] VOLUME button

Adjust the volume.

① [⏻] POWER button

[⏻] Turn the power On.
[⏻] Turn the power Off.

② [PLAY] buttons

Fast Rewind/Play/Fast forward/Stop/Pause.

③ [🏠] HOME button

Access the OSD menu.

④ [📺] SOURCE button

Choose input source. Press [🏠] or [📺] button to choose from **USB, Network, HDMI 1, HDMI 2, DisplayPort, DVI-D, YPbPr, AV** or **VGA**. Press [OK] button to confirm and exit.

⑤ [☰] LIST button

Reserved.

2.3.2. ID Remote Control

Set remote control ID number when using several displays.

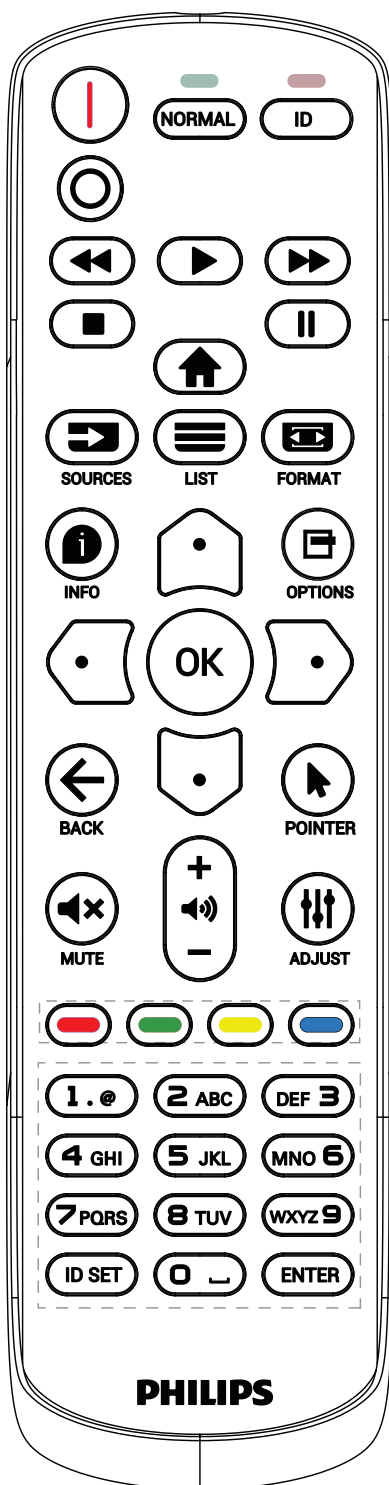

Press [ID] button. The red LED blinks twice.

1. Press [ID SET] button for more than 1 second to enter the ID Mode. The red LED lights up.
Press the [ID SET] button again to exit from ID mode. The red LED lights off.

Press the digit numbers [0] ~ [9] to select the display you want to control.

For example: press [0] and [1] for display No.1, press [1] and [1] for display No.11.

The numbers available are from [01] ~ [255].

2. Not pressing any button within 10 seconds will exit the ID Mode.
3. If a wrong button is pressed, wait 1 second after the red LED lights off and then lights up again, then press the correct digits again.
4. Press [ENTER] button to confirm. The red LED blinks twice and then lights off.

NOTE:

- Press [NORMAL] button. The green LED blinks twice, indicating the display is in normal operation.
- It is necessary to set up the ID number for each display before selecting its ID number.
- Use “||” (pause) key on the remote control to freeze the screen. Use “▶” (play) key on the remote control to unfreeze the screen.
- The “freeze” feature only can be adopted on “real” video sources like VGA, AV, YPbPr, HDMI, DVI, DP.
- Any operation on the remote control or video mode change will unfreeze the screen.

2.3.3. Inserting the batteries in the remote control

The remote control is powered by two 1.5V AAA batteries.

To install or replace batteries:

1. Press and then slide the cover to open it.
2. Insert batteries with the correct polarity (+) and (-).
3. Replace the cover.

Caution:

Incorrect use of batteries may cause leakage or explosion. Be sure to follow the instructions below:

- Insert “AAA” batteries with the correct polarity (+ and -).
- Do not mix battery types.
- Do not use a new battery with a used one together. Otherwise, it may cause leakage or shorten the life of the batteries.
- Remove the dead batteries immediately to avoid battery leakage in the battery compartment. Do not touch exposed battery acid, as it may cause injury to your skin.
- Disposal of a battery into fire or a hot oven, or mechanically crushing or cutting of a battery, that can result in an explosion; leaving a battery in an extremely high temperature surrounding environment that can result in an explosion or the leakage of flammable liquid or gas; and a battery subjected to extremely low air pressure that may result in an explosion or the leakage of flammable liquid or gas.

Note: Remove the batteries from the battery compartment when not using for an extended period of time.

2.3.4. Handling the remote control

- Do not drop or apply shock to the remote control.
- Do not allow any liquid to get inside the remote control. If water has entered the remote control, wipe the remote control with a dry cloth immediately.
- Do not place the remote control near heat and steam sources.
- Do not attempt to disassemble the remote control, unless you need to place batteries in the remote control.

2.3.5. Operating range of the remote control

Pointing the remote control at the remote sensor on the display.

Use the remote control within 5 m from the sensor on the display at an angle of 20 degrees from the left and right.

NOTE:

- The remote control may not function properly when the remote control sensor on the display is under direct sunlight or strong illumination, or when an obstacle blocks the signal transmission.
- Use an IR sensor cable for better performance of the remote control. (Refer to 3.5. IR connection for details)

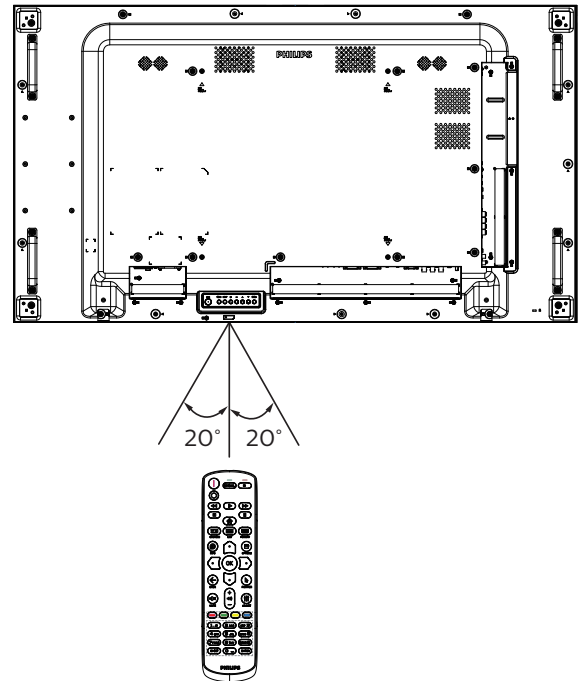

3. Connecting External Equipment

3.1. Connecting External Equipment (DVD/VCR/VCD)

3.1.1. Using COMPONENT video input

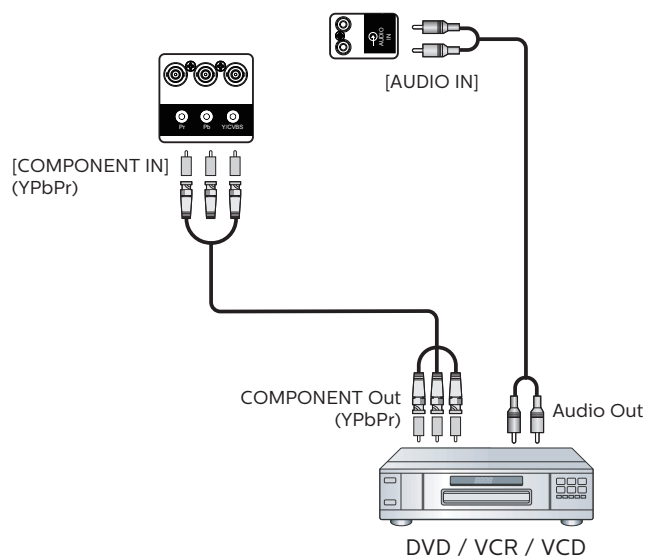

3.1.2. Using Video Source input

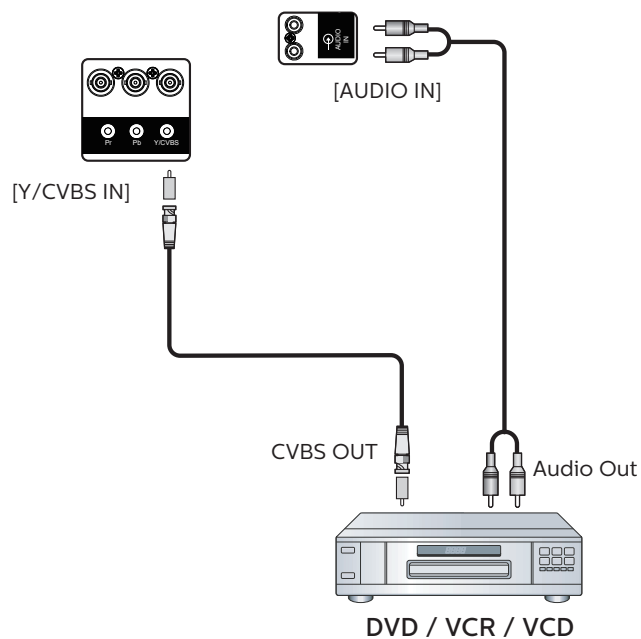

3.1.3. Using HDMI video input

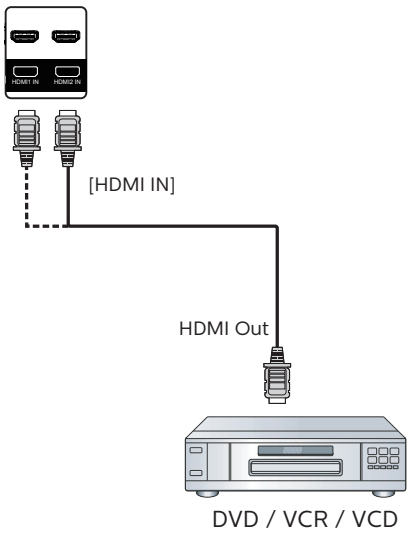

3.2. Connecting a PC

3.2.1. Using VGA input

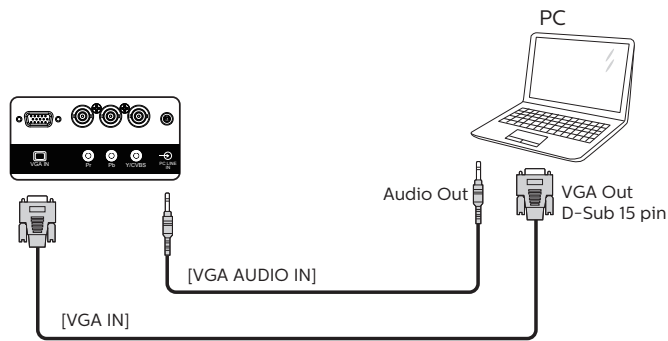

3.2.2. Using DVI input

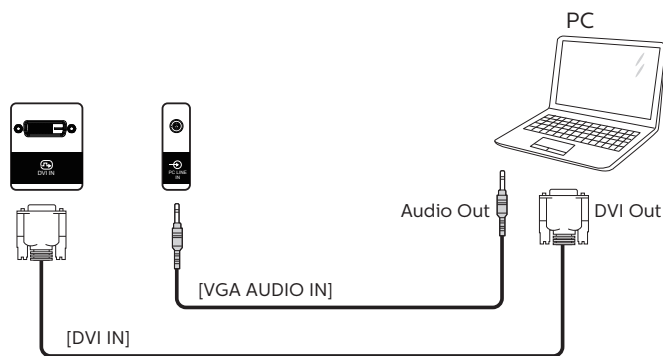

3.2.3. Using HDMI input

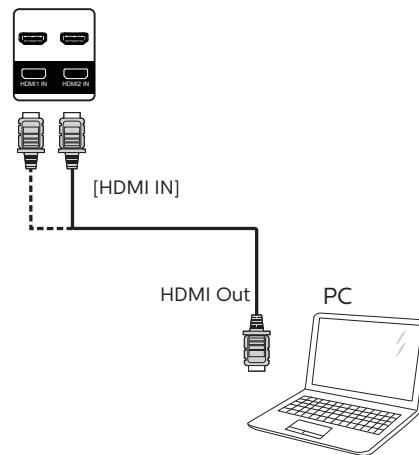

3.2.4. Using DisplayPort input

3.3. Connecting Audio Equipment

3.3.1. Connecting external speakers

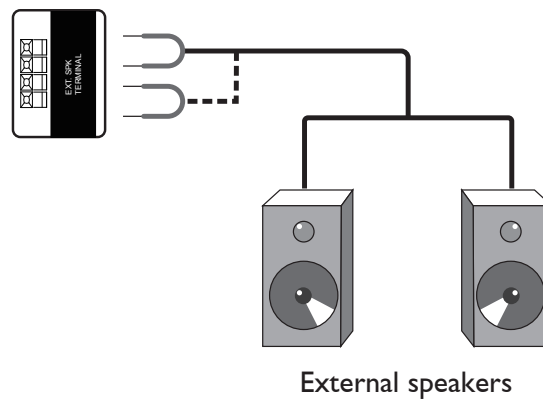

3.4. Connecting Multiple Displays in a Daisy-chain Configuration

You can interconnect multiple displays to create a daisy-chain configuration for applications such as a menu board.

3.4.1. Display control connection

Connect the [RS232C OUT] connector of DISPLAY 1 to the [RS232C IN] connector of DISPLAY 2.

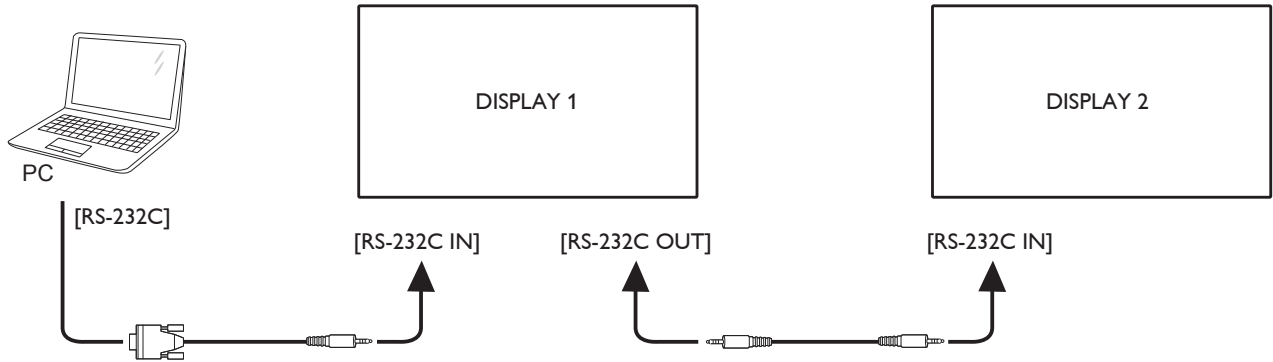

3.4.2. Digital video connection

Connect the [DP OUT] connector of DISPLAY 1 to the [DP IN] connector of DISPLAY 2.

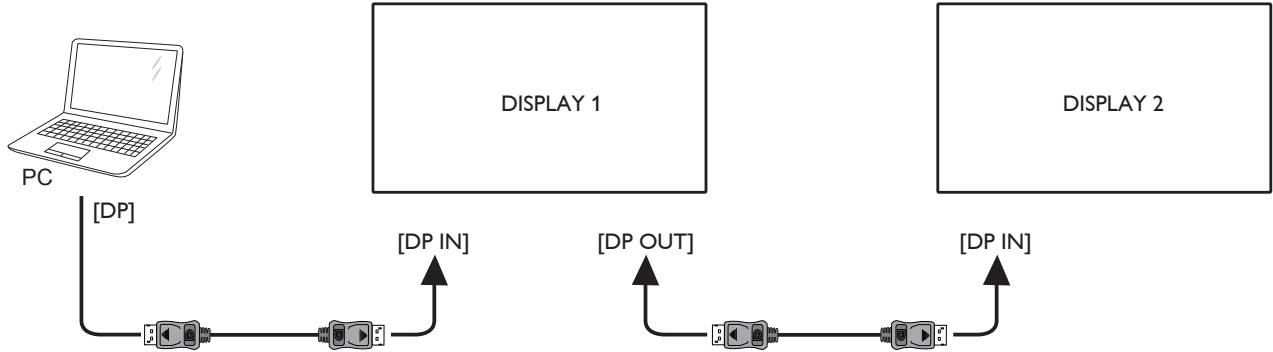

3.5. IR connection

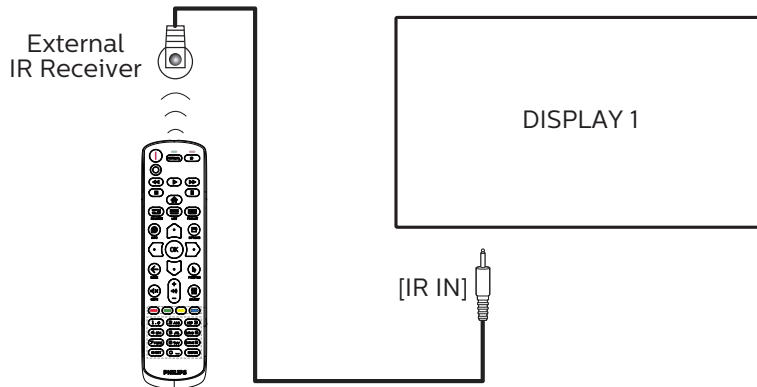

NOTE:

This display's remote control sensor will stop working if the [IR IN] is connected.

3.6. IR Pass-through Connection

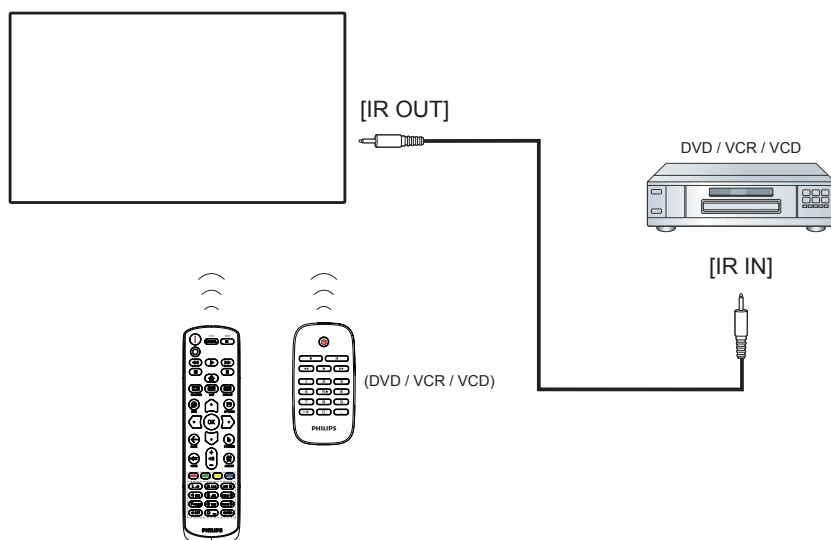

3.7. Wire-connecting to Network

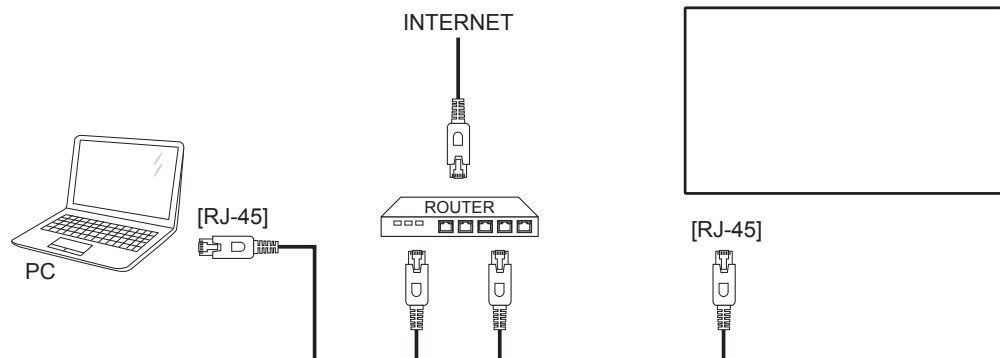

Network Settings:

1. Switch the router on and enable its DHCP setting.
2. Connect the router to this display with an Ethernet cable.
3. Press [**HOME**] HOME button on the remote control, then select **Setup**.
4. Select **Connect to network**, then press [**OK**] button.
5. Wait until this display finds the network connection.
6. If the "End User License Agreement" window prompts, accept the agreement.

Note: Connecting with a shielded CAT-5 Ethernet cable to comply with the EMC directive.

4. Operation

Note: The control button described in this section is mainly on the remote control unless specified otherwise.

4.1. Watch the Connected Video Source

See page 11 for external equipments connection.

1. Press [**SOURCE**] button.
2. Press [**HOME**] or [**BACK**] button to choose a device, then press [**OK**] button.

4.2. Change Picture Format

You can change the picture format to suit the video source. Each video source has its available picture formats.

The available picture formats depend on the video source:

1. Press [**FORMAT**] button.
2. Press [**HOME**] or [**BACK**] button to choose a picture format, then press [**OK**] button.
 - **{Auto zoom}**: Enlarge the picture to fill the screen. It is recommended that you select **Auto zoom** for minimal screen distortion. This option is not recommended for HD display and PC.
 - **{Movie expand 16:9}**: Scale 4:3 format to 16:9. Not recommended for HD or PC.
 - **{Wide screen}**: Shows wide screen format content unstretched. Not recommended for HD or PC.
 - **{Unscaled}**: Provide maximum detail for PC. This option is available only when PC mode is selected from the **{Picture}** menu.
 - **{4:3}**: Display the classic 4:3 format.
 - **{Custom zoom}**: Apply the customized zoom settings selected from the sub-menu of **Picture and edges**.

4.3. Play multimedia files via Local Area Network

To play files via Local Area Network, you will need:

- A wired home network, connected with a Universal Plug and Play (uPnP) router.
- Optional: A LAN cable that connects your display to your home network.
- A media server running on your computer.
- Appropriate settings on your computer firewall to allow you to run the media server.

4.3.1. Network settings

1. Connect your display and the computer to the same home network. Refer to the connection diagram as shown below.

2. Switch your PC and router On.

- **Single display setup:**

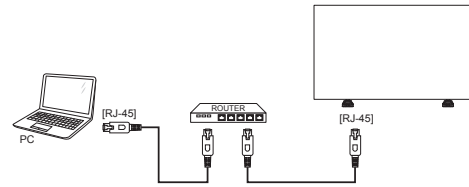

- **Multiple display setup:**

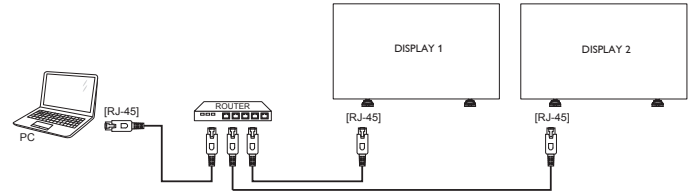

Note: If the apparatus does not return to DLNA mode due to external electrical disturbances (e.g. electrostatic discharge), user intervention is required.

Set up media sharing

1. Install a media server on your computer to share media files. These are some media servers:
 - For PC: Windows Media Player 11 (or higher) or TVersion
 - For Mac: Twonky
2. Switch on media sharing on your computer using the media server. For more information on how to set up the media server, refer to the website of the media server.

4.3.2. How to use DLNA-DMP

Ensure you have connected to the network.

You can press **i** button to display the connection of the network.

| HDMI 1 1080p60 | | 26/09/2014 Friday 09:32:00 |
|-----------------------|-------------------|----------------------------|
| Picture format | Wide screen | |
| Picture style | Standard | |
| Sound style | Personal | |
| Smart power | Off | |
| Volume | 0 | |
| Monitor group | 1 | |
| Monitor ID | 1 | |
| Model name | xxxxxxxx | |
| SWVersion | 1.51 | |
| Serial no | | |
| Temperature | 25°C | |
| Network configuration | DHCP & Auto IP | |
| IP address | 192.168.1.116 | |
| Netmask | 255.255.255.0 | |
| Gateway | 192.168.1.1 | |
| Network name | xxxxxxxx | |
| Ethernet MAC address | FF:FF:FF:FF:FF:FF | |

Play files from display

1. Press [**SOURCE**] button, choose **Network**, and press [**OK**] button.

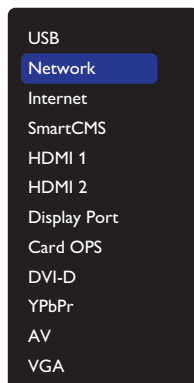

2. As all PCs are connected to the same router now, select the correct one.
3. Press [**HOME**] and [**DIR**] to choose the directory and files to play.
4. You can connect up to 4 displays to the same PC and play the same media stream.

4.3.3. How to use DLNA-DMR from PC

1. Press [**HOME**] button, choose **Network** and press [**OK**] button.

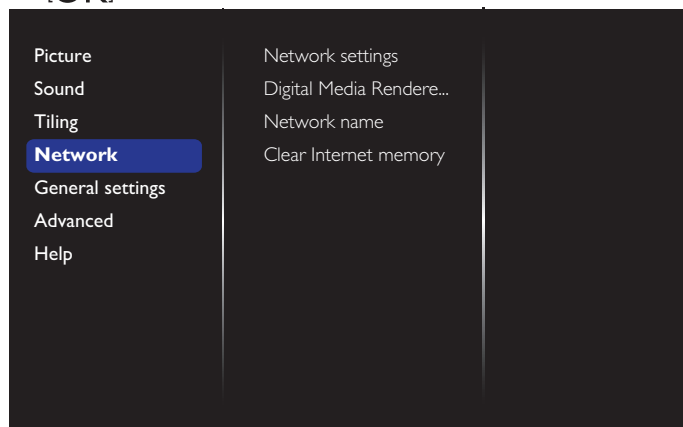

2. Set **Digital Media Renderer DMR** as **ON**.

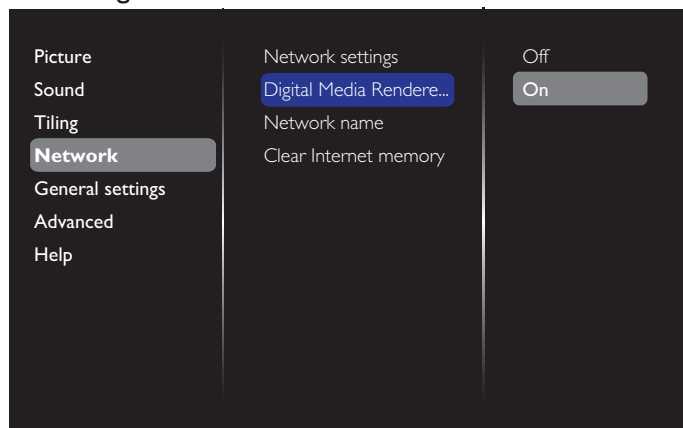

3. Set the name of your display.

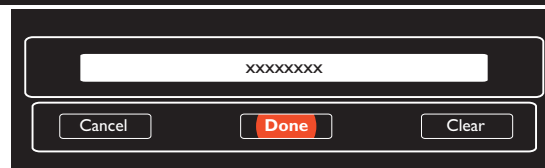
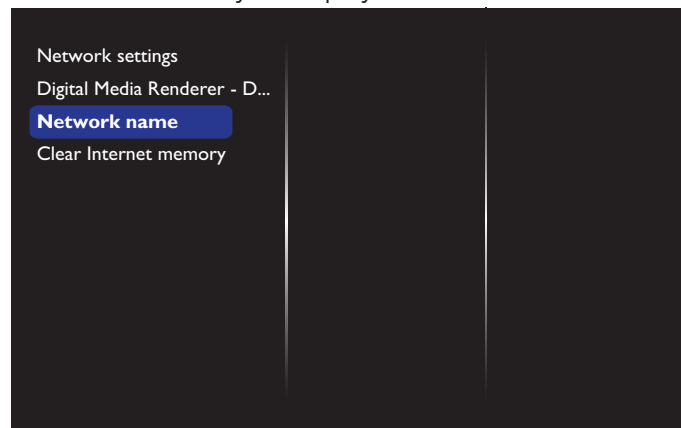

4. Press [**HOME**] button, and press [**SOURCE**] button. Then, choose **Network** and press [**OK**] button.
5. On your PC, go to **Network and Sharing Center**, and click **Choose homegroup and sharing options**.
6. Check the media formats. Then, click **Choose media streaming options....**
7. Go to **Advanced sharing settings**, and click **Turn on network discovery**.
8. Go to the directory of your media files and select the media file by right clicking on it. From the sub-menu of **Play To**, you can find all displays that are connected to your network. Select the display and the media file to play.

Play files

1. Press [**SOURCE**] button.
2. Choose **Network**, and press [**OK**] button.
3. Choose a file from the content browser, and press [**OK**] button to start playing.
4. Press [**PLAY**] button on the remote control to control playing.

Tips:

- Choose the top bar to filter your files by type.
- Choose **Sort** to arrange the files by album name, artist, or other fields.
- To clear the list of offline media servers, press [**OPTIONS**] button. Then, choose **Clear offline servers** and press [**OK**] button.

4.4. Play multimedia files from USB device

1. Connect your USB device to the USB port on the display.

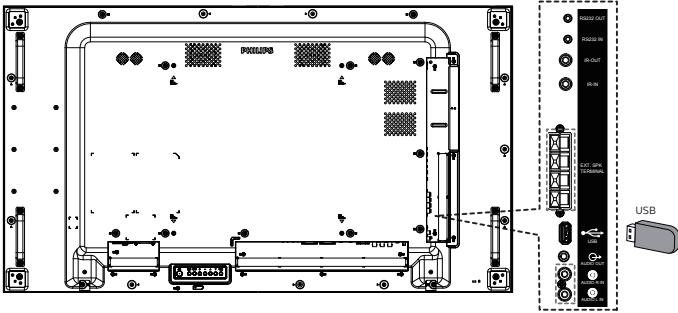

2. Press [] **SOURCE** button, choose **USB**, and press [] **OK** button.

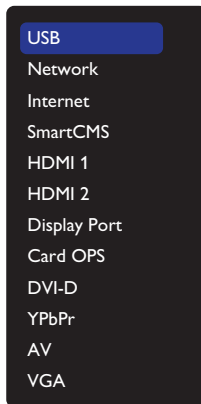

3. The connected USB device is detected automatically for all its playable files, which will be automatically sorted into 3 types: **Music**, **Movie**, and **Photo**.
4. Press [] **BACK** button to go up to the top layer in the screen. Press [] or [] button to choose the file type. Press [] **OK** button to enter its play list.
5. Select your desired file. Press [] **OK** button to start playing.
6. Follow the on-screen instruction to control the play option.
7. Press [] **PLAY** buttons () to control playing.

4.5. Play options

4.5.1. Playing music files

1. Choose **Music** from the top menu bar.



2. Choose one music track, and press [] **OK** button.
 - To play all the tracks in a folder, choose one music file. Then, press [] to **Play All**.
 - To skip to the next or previous track, press [] or [] button.
 - To pause the track, press [] **OK** button. Press [] **OK** button again to resume playback.
 - To skip backward or forward 10 seconds, press [] or [] button.

- To search backward or forward, press [] or [] button, press repeatedly to toggle between different speeds.
- To stop the music, press [] button.

Music options

While you play the music, press [] **OPTIONS** button, then press [] **OK** button to choose an option:

- {**Shuffle**}: Songs are played in a randomized order.
- {**Repeat**}: Choose [] **Repeat** to play a track or an album repeatedly, or choose [] **Play once** to play a track once.

Note: To view information about a song (for example, title, artist or duration), choose the song, then press [] **INFO** button. To hide the information, press [] **INFO** button again.

4.5.2. Playing movie files

1. Choose **Movie** from the top menu bar.



2. Choose a video, and press [] **OK** button.
 - To play all the videos in a folder, choose one video file. Then, press [] to **Play All**.
 - To pause the video, press [] **OK** button. Press [] **OK** button again to resume playback.
 - To skip backward or forward 10 seconds, press [] or [] button.
 - To search backward or forward, press [] or [] button, press repeatedly to toggle between different speeds.
 - To stop the video, press [] button.

Movie options

While playing the video, press [] **OPTIONS** button, then press [] **OK** button to choose an option:

- {**Subtitles**}: Choose the available subtitle settings.
- {**Subtitle language**}: Choose the language for subtitles if available.
- {**Shuffle**}: Videos are played in a randomized order.
- {**Repeat**}: Choose [] **Repeat** to play the video file repeatedly or [] **Play once** to play the video file once.
- {**Status**}: To view information about a video (for example, played position, duration, title, or date).

4.5.3. Playing photo files

1. Choose  **Photo** from the top menu bar.



2. Choose a photo thumbnail, then press [OK] button.

Start a slideshow

If there are multiple photos in a folder, choose a photo. Then, press [▶] to **Play All**.

- To skip to the previous or next photo, press [◀] or [▶] button, and then press [OK] button.
- To stop the slideshow, press [i] button.

Slideshow options

While you play a slideshow, press [≡] **OPTIONS** button, then press [OK] button to choose an option:

- **[Shuffle]**: Pictures are played in a randomized order.
- **[Repeat]**: Choose **[Repeat]** to watch a slideshow repeatedly or **[Play once]** to watch once.
- **[Slideshow Time]**: Choose the displaying time for each photo in the slideshow.
- **[Slideshow Transitions]**: Choose the transition from one photo to the next.

4.6. How to use Opera browser (HTML5)

Please check the LAN wire to make sure the network is connected.

1. Press [➔] **SOURCE** button, and choose **Internet** and press [OK] button.

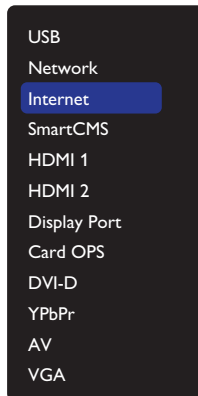

2. Move the cursor to URL address bar. Press [OK] button and a pop-up on-screen keypad appears. You can move the cursor to enter the URL address. After finishing the URL address, choose **Done**.

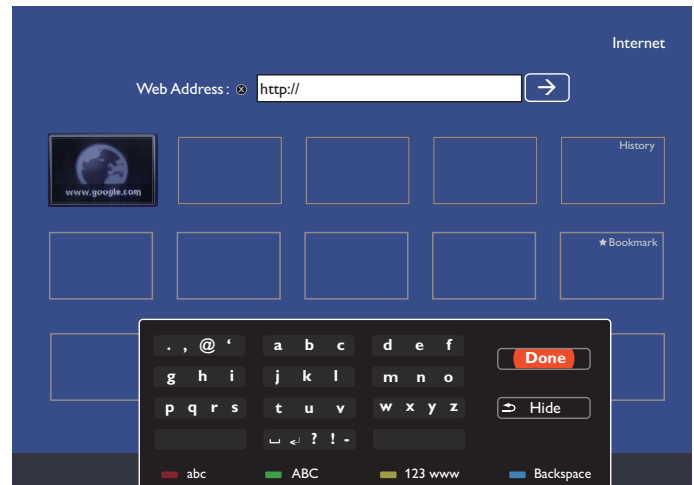

3. Move the cursor to "→" icon and press [OK] button.

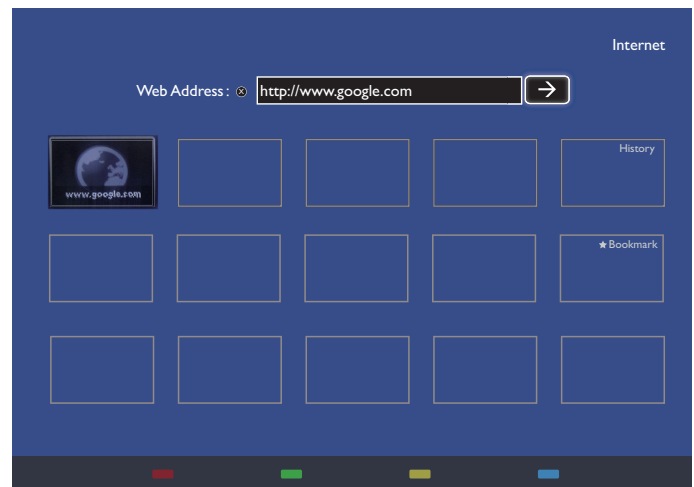

4. A web page appears as shown below:

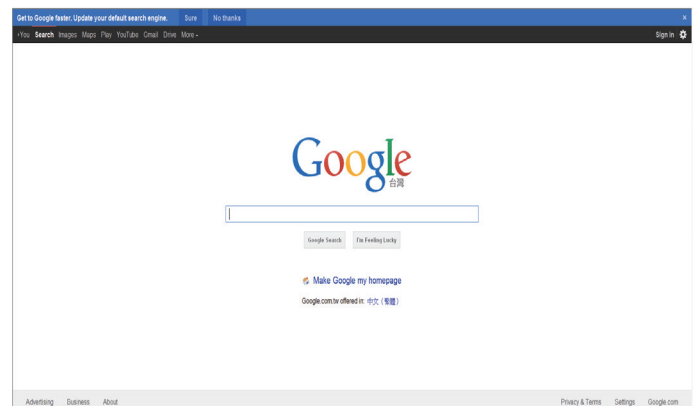

NOTES:

- The Opera browser does not support FLASH format.
- The browser is not a video source. It will not stay at the browser screen after you restart the display.

5. Change your settings

Using the remote control:

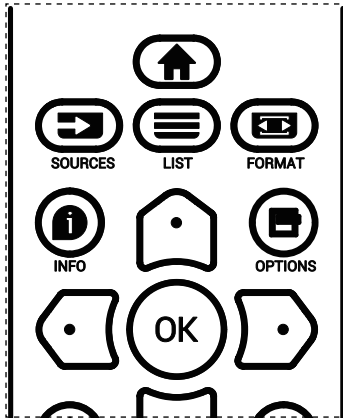

1. Press [**HOME**] button on the remote control to display the OSD menu.
2. Press [**UP**] or [**DOWN**] button to choose the item to be adjusted.
3. Press [**OK**] or [**RIGHT**] button to enter the submenu.
4. In the submenu, press [**UP**] or [**DOWN**] button to toggle between items, press [**LEFT**] or [**RIGHT**] button to adjust settings. If there is a submenu, press [**OK**] or [**RIGHT**] button to enter the submenu.
5. Press [**LEFT**] button to return to the previous menu, or press [**HOME**] button to exit from the OSD menu.

Using the display's control buttons

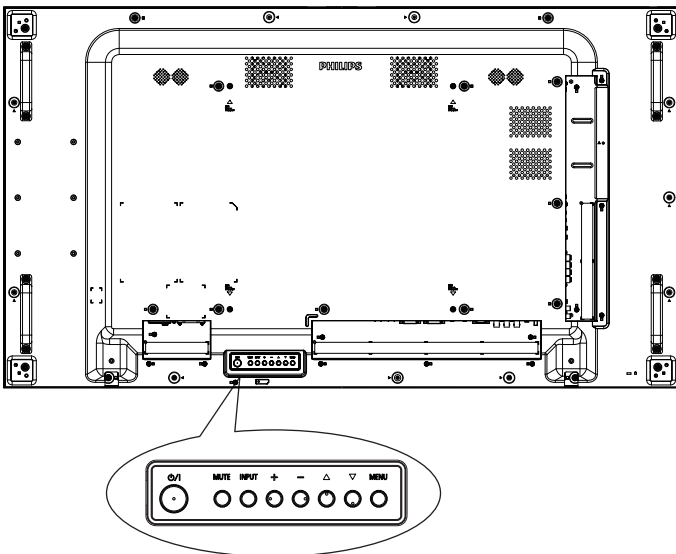

1. Press [**MENU**] button to display the OSD menu.
2. Press [**UP**] [**DOWN**] [**+**] or [**-**] button to choose a menu item or adjust its value.
3. Press [**INPUT**] button to confirm menu selection and enter its submenu.
4. Press [**MENU**] button to exit from the OSD menu.

5.1. Settings

Press [**HOME**] HOME button.

5.1.1. Picture

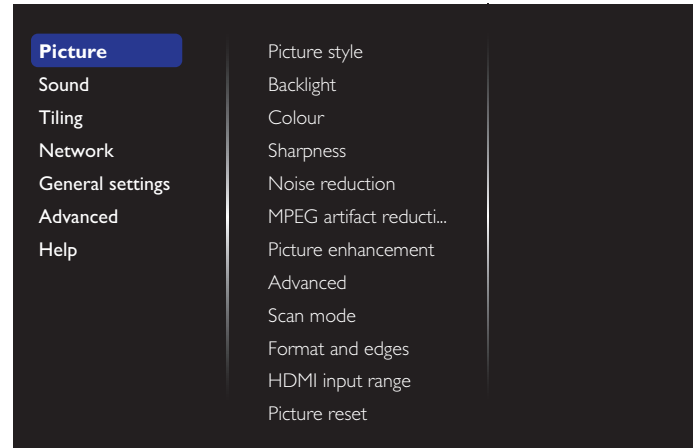

Picture style

Choose a predefined picture setting.

Backlight

Adjust the brightness of this display's backlight.

Colour

Adjust the colour saturation of the picture.

Sharpness

Adjust the sharpness of the picture.

Noise reduction

Choose the amount of noise reduction for the picture.

MPEG artifact reduction

Smoothen transitions and haziness in the digital picture.

Picture enhancement

Fine-tune each pixel to match surrounding pixels and produce a brilliant, high-definition image.

- **{Advanced sharpness}**: Enable superior sharpness, especially on lines and contours of the picture.
- **{Dynamic contrast}**: Dynamically enhance the details in the dark, medium and light areas of the picture.
- **{Colour enhancement}**: Dynamically enhance the vividness and details of colours.

Advanced

Access advanced settings such as gamma, tint, video contrast and so on.

- **{Gamma}**: Adjust the non-linear setting for picture luminance and contrast.
- **{Tint}**: Change the colour balance.
- **{Custom tint}**: Customise colour balance setting. Only available if {Tint} → {Custom} is chosen.
- **{Video contrast}**: Adjust video contrast.
- **{Brightness}**: Adjust screen brightness.
- **{Hue}**: Adjust screen hue.

Scan mode

Change the display area of the image.

Format and edges

- **{Picture format}**: Change the picture format.
- **{Zoom}**: Expand the horizontal and vertical sizes of the image simultaneously.
- **{H Zoom}**: Expand the horizontal size of the image only.
- **{V Zoom}**: Expand the vertical size of the image only.

Note: Zoom, H Zoom and V Zoom are available only when the Picture format setting is set to Custom Zoom.

See page 16 for the descriptions about **Picture format**.

HDMI input range

Color range of HDMI video format

- **{Auto}**: Automatic color range of HDMI video format.
- **{Limit}**: Limited range of HDMI video format.
- **{Full}**: Full range of HDMI video format.

Picture reset

Reset all your picture settings to the factory defaults.

5.1.2. Sound

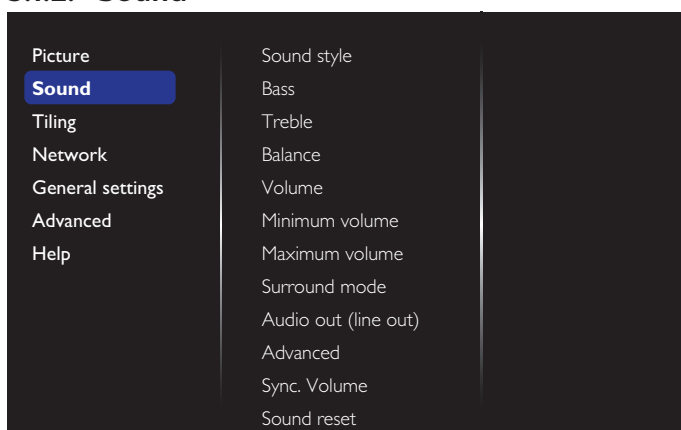

Sound style

Access predefined sound settings.

Bass

Adjust to increase or decrease lower-pitched sounds.

Treble

Adjust to increase or decrease higher-pitched sounds.

Balance

Adjust to emphasize left or right audio output balance.

Volume

Adjust to increase or decrease the volume.

Minimum volume

Set the Minimum volume.

Maximum volume

Set the Maximum volume.

Surround mode

Set surround effects for audio performance.

Audio out (line out)

Adjust audio output volume.

Advanced

Access advanced settings to enhance your audio experience.

- **{Auto volume leveling}**: Enable the reduction of sudden volume changes.
- **{Speaker settings}**: Turn on or off the internal speakers.
- **{Clear sound}**: Enhance sound quality.
- **{Audio out format}**: Choose the type of audio output through the digital audio output connector. (HDMI only)
- **{Audio out delay}**: Automatically synchronize the image on this display to the audio from a connected home theatre.
- **{Audio out offset}**: Adjust the setting for audio output delay. Available if **{Audio out delay}** is switched on.

Sync. Volume

Enable or disable the Sync. Volume function. Set {On} to synchronize the volume of internal speaker and line-out. Set {Off} to adjust the volume of internal speaker and line-out, respectively.

Sound reset

Reset to default setting.

5.1.3. Tiling

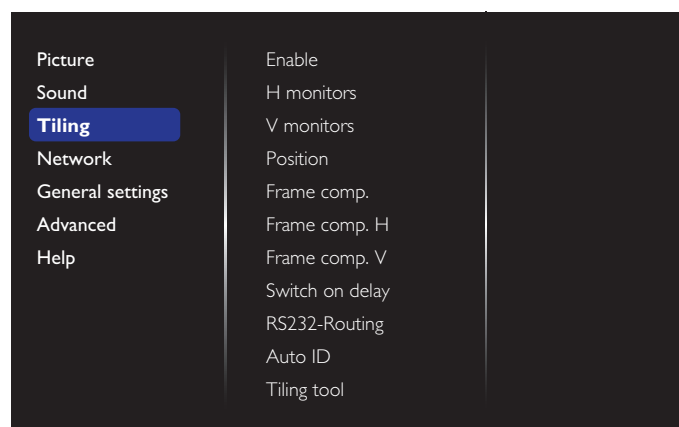

Create a single large-screen matrix (video wall) that consists of up to 100 sets of display (up to 10-sets on the vertical and 10-sets on the horizontal sides).

Enable

Enable or disable the Tiling function. If {On} is selected, the display will apply the settings in {H monitors}, {V monitors}, {Position}, and {Frame comp.}.

H monitors

Adjust the displays on the horizontal side.

V monitors

Adjust the displays on the vertical side.

Position

Adjust the position of this display in the screen matrix.

Example: 2 x 2 screen matrix (4 displays)

H monitors = 2 displays

V monitors = 2 displays

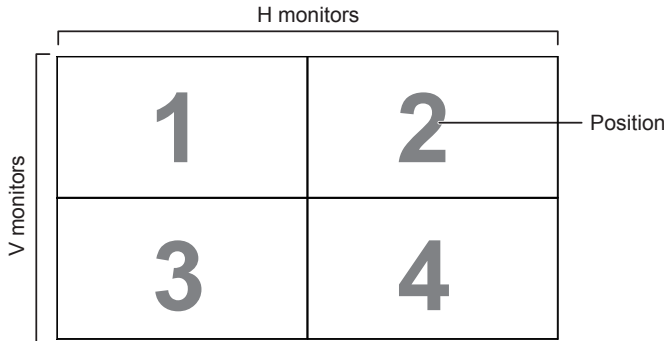
**Example: 5 x 5 screen matrix (25 displays)**

H monitors = 5 displays

V monitors = 5 displays

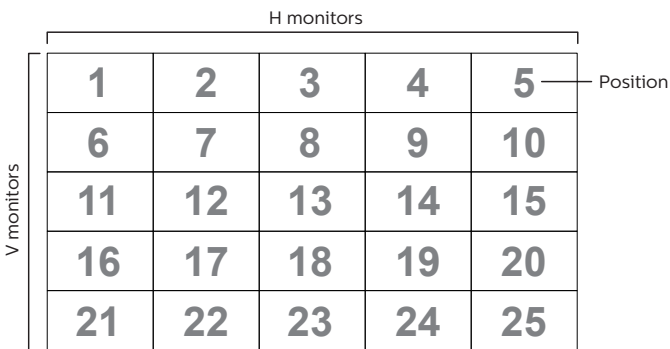
**Frame comp.**

Enable or disable the frame compensation function. If you select {On}, the display will adjust the image to compensate for the width of the display bezels in order to accurately display the image.

{On}

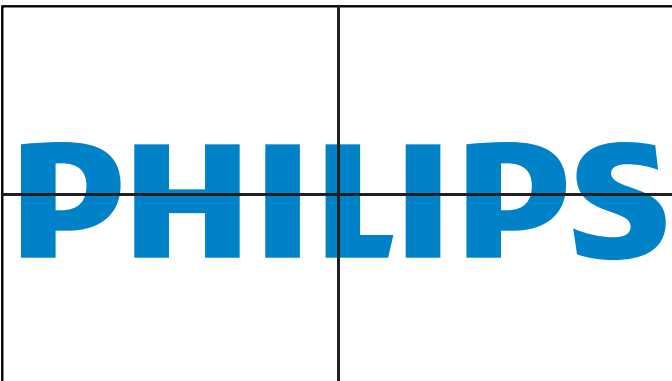

{Off}

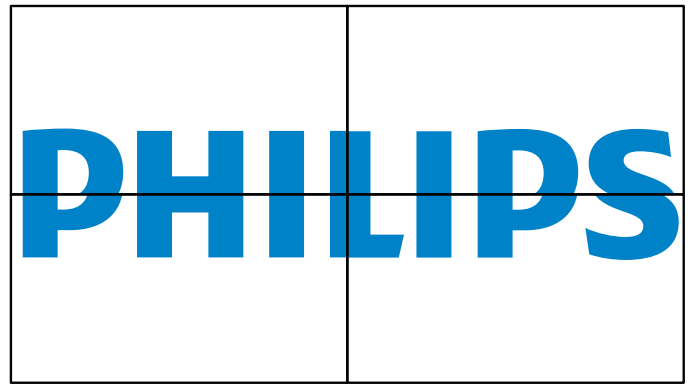
**Frame comp.H**

Adjust the horizontal frame compensation.

Frame comp.V

Adjust the vertical frame compensation.

Switch on delay

When multiple displays are connected, adjust the power-on delay time (in seconds) for each display to reduce the power load.

RS232-Routing

Select the control port.

- {RS232}: Select RS232 Control.
- {LAN(RJ-45)}: Select LAN control.
- {IR}

Select the operation mode of the remote control when multiple displays are connected via an RS232C connection.

- {IR Control}

Select the operation mode of remote control when multiple displays are connected via an RS232C connection.

- {Normal}

All displays can be operated normally by the remote control unit.

- {Primary}

Designate this display as the primary display for remote control operation. Only this display can be operated by the remote control.

- {Secondary}

Designate this display as the secondary display. This display can not be operated by the remote control, and will only receive the control signal from the primary display via the RS232C connection.

- {Control Monitor-ID}

Select the ID number for the IR control of the display via the RS232C connection.

Auto ID

Set up {Monitor ID} of the connected device according to {H monitors} settings.

Example: H monitors sets as 4

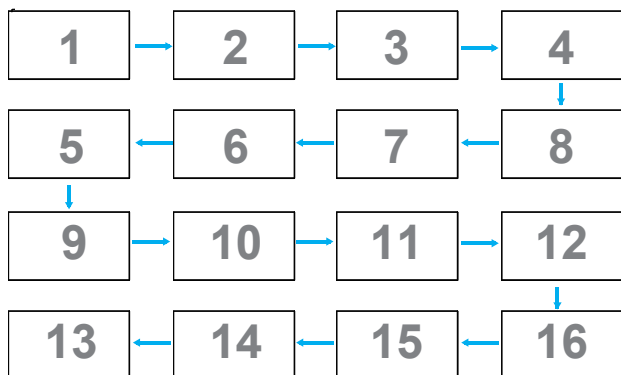

Note: To use this function, serially connect all machines with RS-232 cable and set their Network control port to RS-232.

Note: To use this function for DP 1.2 connectivity, the maximum resolution is 1920x1080@60Hz supported 4sets. For 4Kx2K/30Hz, it only supports 2 sets connectivity.

Tilling tool

Activate the tiling tool function by entering the serial number purchased from dealer.

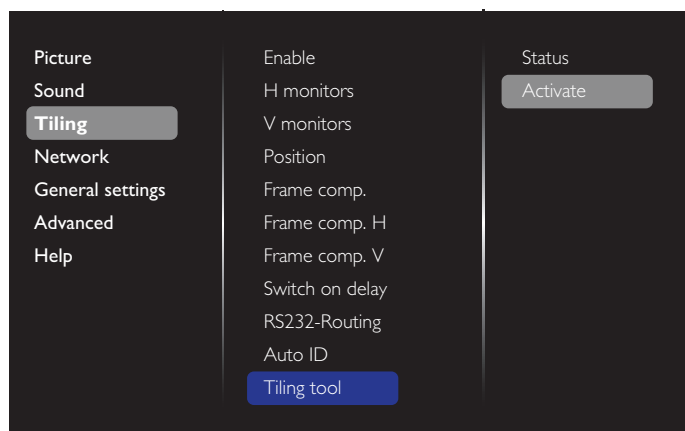

(1). Enter activate menu

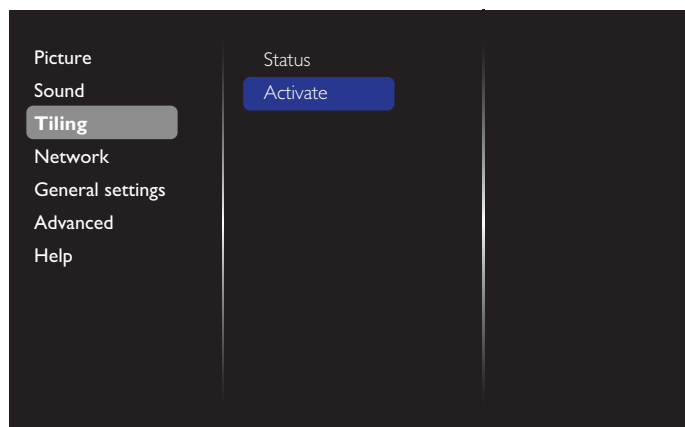

(2). Enter activate key in OSD

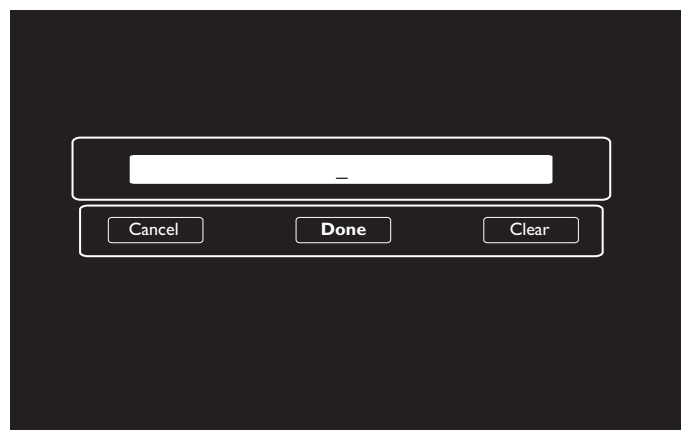

(3). Press **[OK]** button and an on-screen keypad appears to allow you enter the activate key. Select **Done** when you finish.

Note: Press yellow key on the remote control to switch to numeric key.

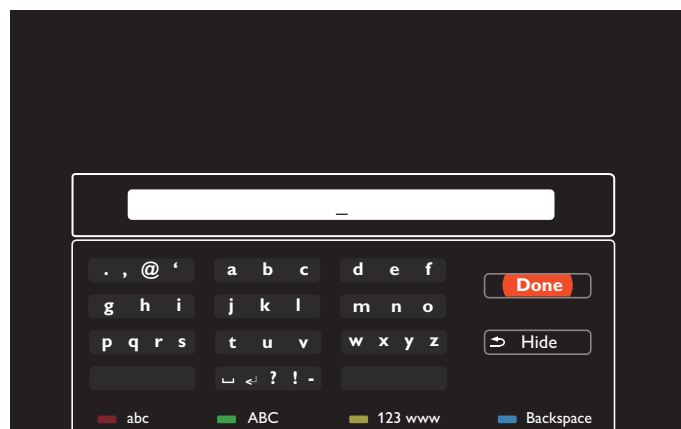

(4). A tiling tool activation prompt is displayed.



(5). Check tiling tool status

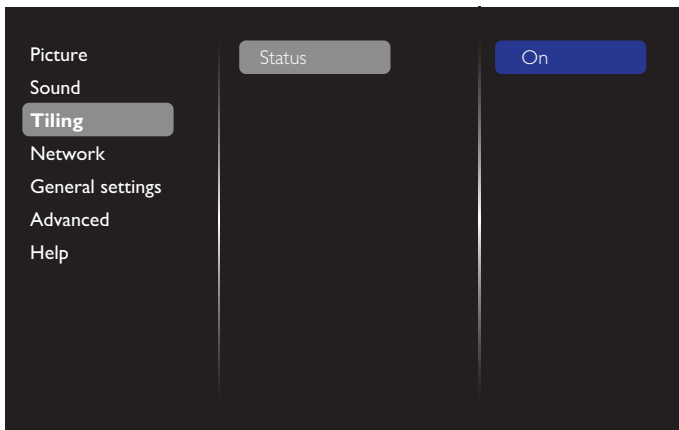

5.1.5. General settings

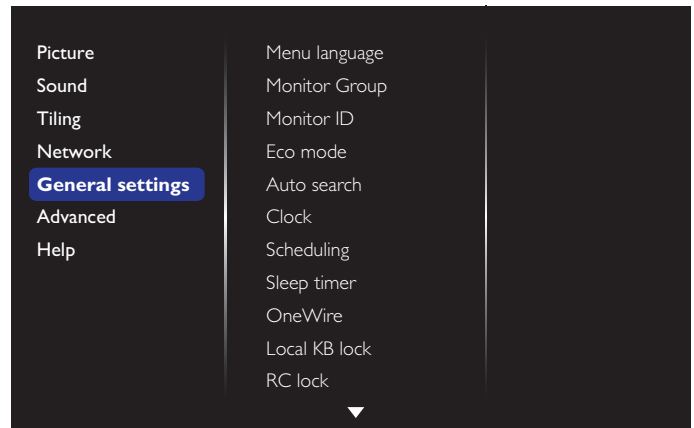
**Menu language**

Set OSD menu language.

Monitor group

Adjust the group range between 1 and 255. The default setting is 255.

Monitor ID

Adjust the ID number for controlling the display via the RS232C connection. Each display must have a unique ID number when multiple sets of display are connected. Monitor ID number range is between 1 and 255. The default setting is 1.

Eco mode

This setting allows you to reduce the power consumption of the display automatically.

Note: If Eco mode is set to “Normal”, you cannot reset it to the default setting which is “low power standby” from the “Factory reset” menu. However, you can still set the Eco mode to “low power standby” manually.

Auto search

By enabling this function, the display detects and displays available signal sources automatically.

Clock

Set the current date and time for the display’s internal clock.
NOTES:

The definition and behavior of the Daylight saving time:
The current implementation of daylight saving is a reminder tool for user who doesn’t know how to adjust the clock for daylight saving. It does not adjust the real time clock automatically. The problem is that there are no standard rules on when to adjust the clock defined by region or country. To solve this problem, user must be able to set the daylight saving start/end date. When daylight saving correction is on (user selectable) then the real time clock should be adjusted at the time set of the daylight saving on/off date. At the start date of daylight saving, the clock should be adjusted 1 hour forward at 2 o’clock. At the end date of daylight saving, the clock should be adjusted 1 hour backward at 2 o’clock.

The existing daylight on/off menu should be replaced with the following menu structure:

Menu item {Daylight saving} opens the sub-menu that contains the following items:

5.1.4. Network

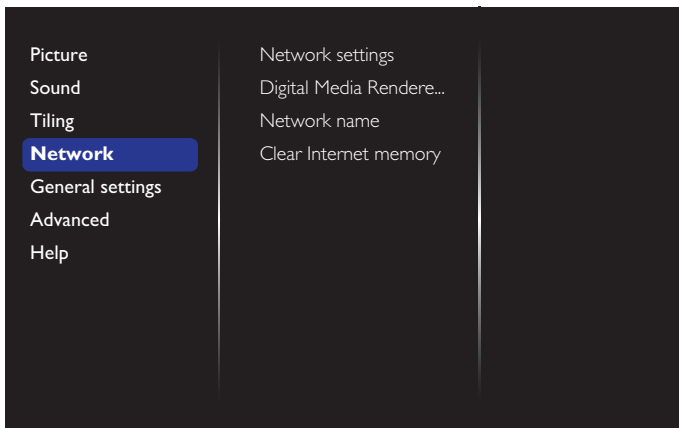
**Network settings**

- {Network configuration}: Choose how this display should assign addresses to the network resources. The available options are {DHCP & Auto IP} (recommended) and {Static IP}.
- {Network type}: Choose Wired (default) to set the network type.

Digital Media Renderer - DMR

Receive multimedia files from the connected device through your network.

Network name

In the multiple-display connection, you can rename each display for easy identification.

Use the on-screen keypad or the remote control keypad to enter the name.

Clear Internet memory

Clear all the cookies, bookmarks, history list and text used for auto fill.

- Menu item {Daylight saving start date} Selection item {1st, 2nd, 3rd, 4th, last} Sunday of selection item {1-12 month}
- Menu item {Daylight saving stop date} Selection item {1st, 2nd, 3rd, 4th, last} Sunday of selection item {1-12 month}
- Menu item {Correction time} Selection item {0.5, 1.0, 1.5, 2.0} hour
- Menu item {Daylight saving} Selection item {on, off}

When “daylight saving” is “on”, the real time clock will be adjusted automatically at the daylight saving time (e.g. April 5, 2015, 02.00 o'clock: time will be set 1 hour later or October 25, 2015, 02.00 o'clock: time will be set 1 hour earlier).

Scheduling

This function allows you to program up to 7 different scheduled time intervals for this display to activate.

You can set:

- Which input source the display will use for each scheduled activation period.
- The time for the display to turn on and turn off.
- The days in a week for the display to activate.

NOTES:

- It is recommended that you set up the current date and time in the {Clock} menu before using this function.
- After changing the {Clock} option in the {General settings} menu, you need to set this {Scheduling} again.

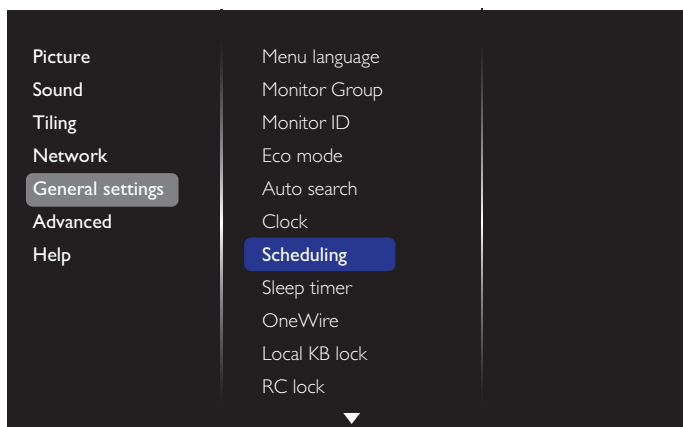

1. You can set up to 7 schedules. Go to **Status** and choose **On**.

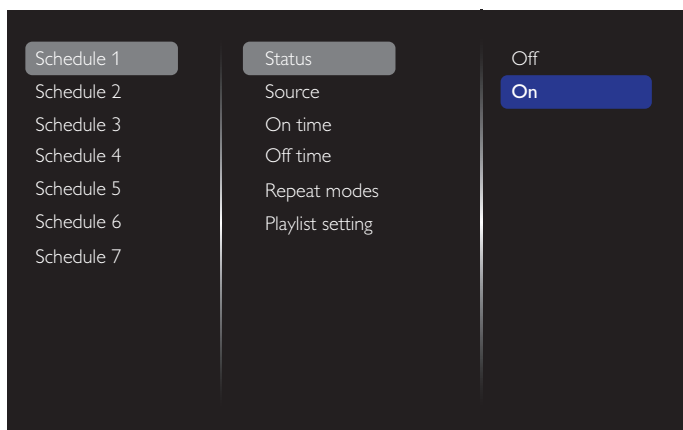

2. Go to **Source** and select the input source. If {Source} → {USB playlist} is selected, you need to set the playlist. If {Source} → {Internet} is selected, you need to set the URL address.

Note: If {Source} → {Autoplay} is chosen, you need to create a folder named “philips” in the root directory of the USB and place the files (pictures or videos) to display in the folder.

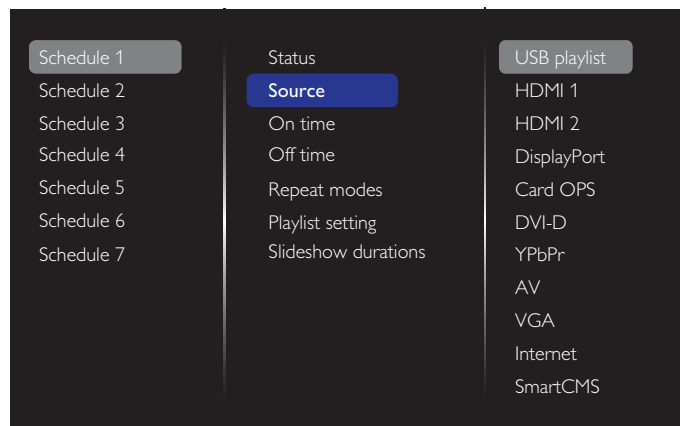

3. Set **On time**.

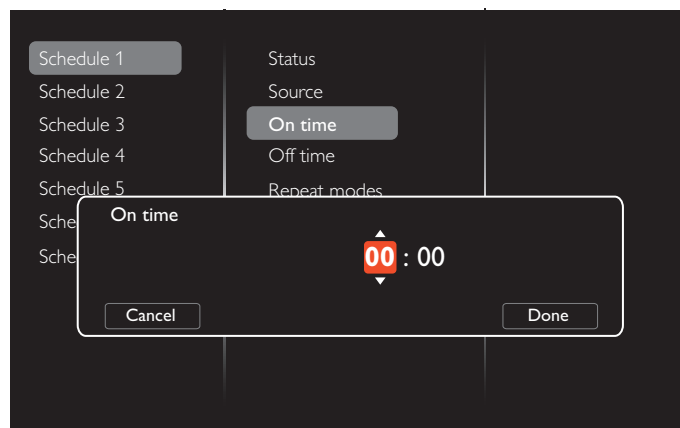

4. Set **Off time**.

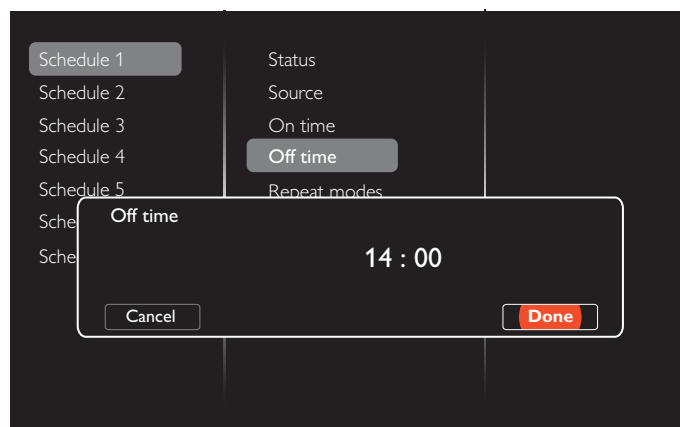

5. Go to **Repeat modes** and select the repeat mode.

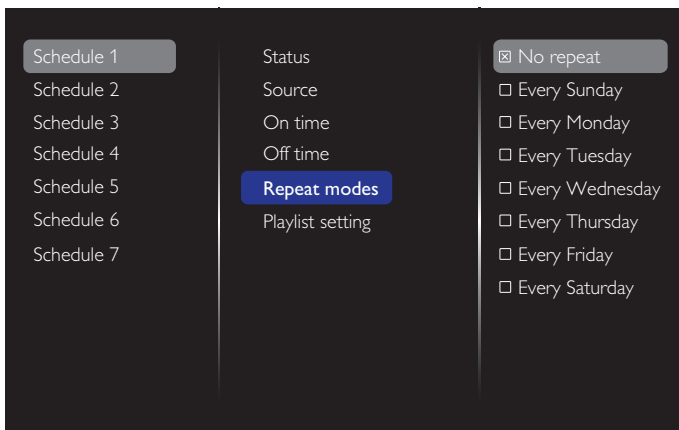

6. If {Source} → {USB} is chosen. Go to **Playlist setting**.

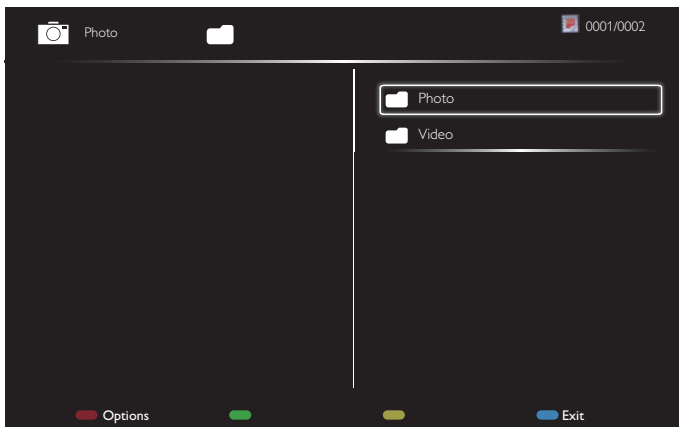

- Press [⏪] [⏩] buttons to choose files.
- Press [⏮] [⏭] buttons to switch between Playlist and File Manager.
- Press [OK] button to set or clear the playlist.

7. To save the playlist, press [] and choose **Save list**.

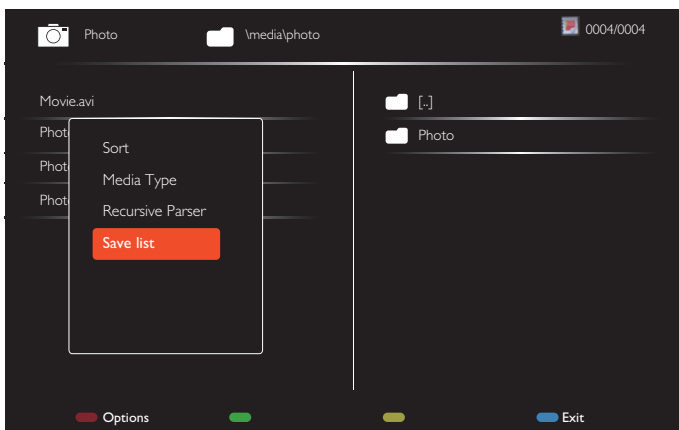

NOTES:

- Each Playlist supports up to 30 files.
- Playlist will not be cleared even you set the default settings in the {Factory settings} menu. You have to manually remove the files or delete “usb_schedulinglist.txt” from the USB.

Sleep timer

Shut off the display after a preset period of time.

OneWire

Connect and control your HDMI-CEC compliant devices through HDMI port to this display with the same remote control.

Local KB lock

Enable or disable the keyboard (control buttons) function of the display.

- {Unlock}: Enable the keyboard function.
- {Lock all}: Lock all keyboard function.
- {Lock but volume}: Disable all keyboard functions except the [←] and [→] buttons.
- {Lock but power}: Disable all keyboard functions except the [] button.
- {Lock all expect volume and power}: Disable all keyboard functions except the [←], [→] and buttons.

RC lock

Choose to enable or disable the button function of the remote control.

- {Unlock}: Enable the remote control function.
- {Lock all}: Lock all remote control functions.
- {Lock but volume}: Disable all remote control functions except the [←] and [→] button.
- {Lock but power}: Disable all remote control functions except the [] POWER button.
- {Lock all expect volume and power}: Disable all remote control functions except the [←] [→] and [] POWER buttons.

Note: To disable the lock function from **Local KB lock** or **RC lock**, press buttons [] and 1 9 9 8 on the remote control.

Pixel shift

For video input sources, you may choose {On} to move the screen image automatically to protect the display from “burn-in” or “after-image” symptoms when there is no operation for 30 seconds.

Smart power

Choose a backlight level to optimise dynamic power consumption and picture contrast.

The options are: {Off}, {Standard}, {Medium}, {High}.

Wake on lan

Choose {On} to turn on the display by network.

Switch on state

Choose the status that will apply to your display when you connect the power cord next time.

- {On} - The display will turn on when the power cord is connected to a wall outlet.
- {Standby} - The display will remain in Standby mode when the power cord is connected to a wall outlet.
- {Last status} - The display will return to the previous power status (on/off/standby) when removing and replacing the power cord.

Light sensor

Choose {On} and the display will automatically adjust the backlight. This option is only available when you plug in CRD41.

Human sensor

Set the display to turn on the backlight if human presence is detected and turn off the backlight after a preset period of time.

The options are: {Off, 10~60} minutes. This item is only available when you plug in CRD41.

Power LED Light

Choose {Off} to turn off the power LED indicator.

Logo

Choose {Off} and Philips logo will not appear when you turn the display On.

Advanced power management

When this function is set to {On}, the display will automatically turn off if no signal is detected.

Source notification

When you press [|]POWER button to turn on the display from standby mode or change the input signal, the information OSD is displayed on the top left side of the screen.

Choose {Off} to disable this function.

DisplayPort Ver.

Set the DisplayPort version to 1.1a or 1.2, this setting is only valid on DisplayPort input and output,

1.1a: Switch DisplayPort Ver. to 1.1a(default), the DisplayPort output is the clone of the DisplayPort input.

1.2: Switch DisplayPort Ver. to 1.2 to support MST(Multi-Stream Transport)

Notes:

- If the display shows a black screen or works abnormally under DisplayPort source, please switch to 1.1a and turn AC off and on.
- For DP daisy chain application, please select the same DP version for all PD.

Cooling Fan

Select {On} to turn on the cooling fan permanently. Select {Auto} to turn on/off the cooling fan according to the display's temperature.

NOTES:

- The default {Auto} option will start running the cooling fan if the temperature reaches 45°C (113°F). The cooling fan will stop running if the temperature reaches 43°C (109°F).
- A temperature-warning message will be shown on the screen if the temperature reaches 58°C (136°F). All key functions except [|]key will then be disabled.
- Once the temperature reaches 60°C (140°F), the display power will be shut down automatically.

Factory settings

Reset all your customized settings to the factory defaults.

5.1.6. Advanced

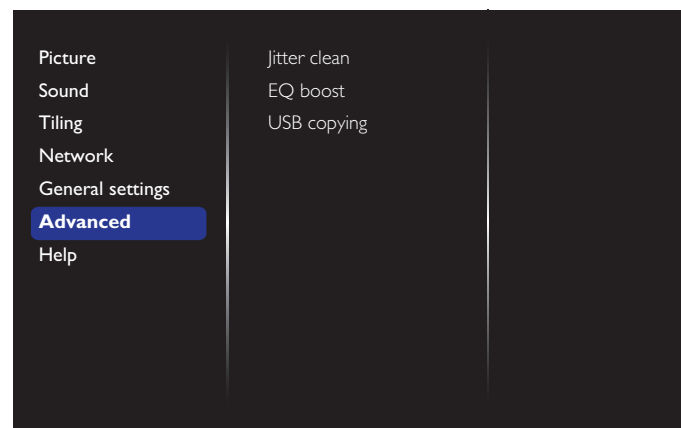

Jitter clean

Turn on/off Jitter cleaning function for HDMI and DVI signal quality enhancement. The default setting is on.

EQ boost

Adjust digital signal of EQ boost.

USB copying

Copy user logo "Welcomelogo.png" to internal memory .

5.1.7. Help

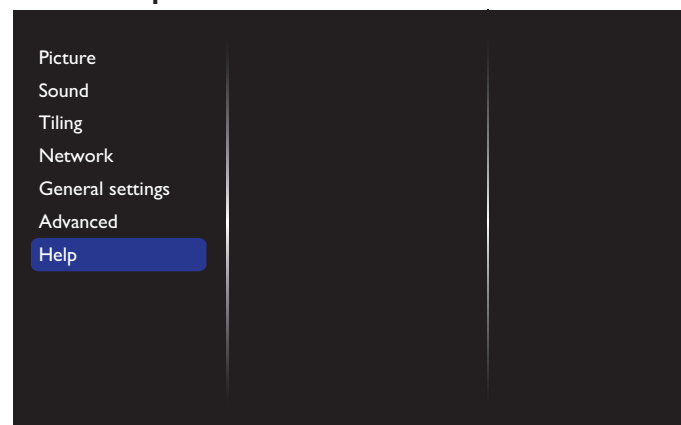

6. USB device compatibility

USB Video Subtitle Formats (for language subtitles, etc.)

| File Extensions | Container | Video codec | Maximum resolution | Max. Frame Rate (fps) | Max. Bit Rate (Mbps) | Audio codec |
|------------------------------|-----------|---------------|---|-----------------------|----------------------|--|
| .mpg mpeg .vob | PS | MPEG-1 | 1920x1080 | 25p,30p,50i,60i | 30 | MPEG-1(L1&L2), MPEG-1,2,2.5 L3, AAC/HE- AAC(v1&v2), DVD-PCM |
| | | MPEG-2 | 1920x1080 | 25p,30p,50i,60i | 30 | |
| | | MPEG-4 ASP | 1920x1080 | 25p,30p,50i,60i | 30 | |
| | | H.264 | 1920x1080 | 25p,30p,50p,60p,60i | 30 | |
| .ts | TS | MPEG-2 | 1920x1080 | 25p,30p,50i,60i | 30 | MPEG-1(L1&L2), MPEG-1,2,2.5 L3, AAC/HE-AAC (v1&v2) |
| | | MPEG-4 ASP | 1920x1080 | 25p,30p,50i,60i | 30 | |
| | | H.264 | 1920x1080 | 25p,30p,50p,60p,60i | 30 | |
| | | MVC | 1920x1080i@field rate=50, 60Hz 1920x1080p@frame rate=24, 25,30Hz 1280x720p@frame rate=50, 60Hz | - | 30 | |
| .ts .m2ts .mts .mt2 | MaTS TTS | MPEG-2 | 1920x1080 | 25p,30p,50i,60i | 30 | MPEG-1(L1&L2), MPEG-1,2,2.5 L3, AAC/HE-AAC (v1&v2) |
| | | MPEG-4 ASP | 1920x1080 | 25p,30p,50i,60i | 30 | |
| | | H.264 | 1920x1080 | 25p,30p,50p,60p,60i | 30 | |
| | | MVC | 1920x1080i @ field rate=50, 60Hz 1920x1080p @ frame rate=24, 25,30Hz 1280x720p @ frame rate=50, 60Hz | - | 30 | |
| .ts .m2ts .mts | AVCHD | MPEG-2 | 1920x1080 | 25p,30p,50i,60i | 30 | MPEG-1(L1&L2), MPEG-1,2,2.5 L3, AAC/HE-AAC (v1&v2) |
| | | MPEG-4 ASP | 1920x1080 | 25p,30p,50i,60i | 30 | |
| | | H.264 | 1920x1080 | 25p,30p,50p,60p,60i | 30 | |
| .ts .m2ts .mts | AVCHD | MVC | 1920x1080i@field rate=50, 60Hz 1920x1080p@frame rate=24, 25,30Hz 1280x720p @ frame rate=50, 60Hz | - | 30 | MPEG-1(L1&L2), MPEG-1,2,2.5 L3, AAC/HE-AAC (v1&v2) |
| .m4v | M4V | H.264 | 1920x1080 | 25p,30p,50p,60p,60i | 30 | AAC |
| .ism/ Manifest .mpd | frag MP4 | H.264 | 1920x1080 | 25p,30p,50p,60p,60i | 30 | AAC/HE- AAC(v1&v2), WMA, WMA-PRO |
| | | MVC | 1920x1080i@field rate=50, 60Hz 1920x1080p@frame rate=24, 25,30Hz 1280x720p @ frame rate=50, 60Hz | - | 30 | |
| .mp4 | MP4 | MPEG-4 ASP | 1920x1080 | 25p,30p,50i,60i | 30 | AAC/HE- AAC(v1&v2), WMA, WMA-PRO |
| | | H.264 | 1920x1080 | | 30 | |
| | | MVC | 1920x1080i@field rate=50, 60Hz 1920x1080p@frame rate=24, 25,30Hz 1280x720p @ frame rate=50, 60Hz | - | 30 | |
| | | WMV9/VC1 | 1920x1080 | 30p,60i | 30 | |
| .mkv .mk3d | MKV | MPEG-4 ASP | 1920x1080 | 25p,30p,50i,60i | 30 | MPEG-1(L1&L2), MPEG-1,2,2.5 L3, AAC/HE-AAC (v1&v2), WMA, WMA-PRO |
| | | H.264 | 1920x1080 | | 30 | |

USB Multimedia Formats

| File Extensions | Container | Video codec | Maximum resolution | Frequency (kHz) | Max.Bit Rate (Mbps) | Audio codec |
|-------------------------|------------------------|-------------|--------------------|-----------------|---------------------|-------------------|
| .mp3 | MP3 | - | - | 48 | 384 | MPEG-1,2,2.5 L3 |
| .wma .asf | WMA (V2 up to V9.2) | - | - | 48 | 192 | WMA |
| .wma | WMA Pro | - | - | 96 | 768 | WMA,WMA Pro |
| .wav(PC) | LPCM | - | - | 192 | 768 | LPCM |
| .aif(mac) .aiff(mac) | LPCM | - | - | 192 | 768 | LPCM |
| .aac .mp4 .m4a | AAC | - | - | 48 | 1024 | AAC,HE-AAC(v1&v2) |
| .pls .m3u | Playlists | - | - | - | - | - |
| .m4a | M4A | - | - | 48 | 1024 | AAC,HE-AAC(v1&v2) |

USB Photo Formats

| File Extensions | Container | Video codec | Maximum Resolution | Frequency | Max.Bit Rate | Audio codec |
|-----------------|-----------|-------------|--|-----------|--------------|-------------|
| jpg/jpeg | JPEG | | baseline: color mode = 444, size <=32768x16128 color mode = 422v, size <= 16384x16128 color mode = other, not support | - | - | - |
| bmp | BMP | | 4096x3072_4bit, 2730x2500_8bit, 2048x1536_16bit, 1500x1200_32bit | - | - | - |
| png | PNG | | 4096x3072_4bit, 2730x2500_8bit, 2048x1536_16bit, 1500x1200_32bit | - | - | - |
| gif | GIF | | 4096x3072_4bit, 2730x2500_8bit, 2048x1536_16bit, 1500x1200_32bit | - | - | - |

NOTES:

- Sound or video may not work if the contents have a standard bit rate/frame rate above the compatible Frame/sec listed in the table above.
- Video content with a Bit rate or Frame rate larger than the rate specified in the table above can cause choppy video during playback.

7. Input Mode

VGA Resolution:

| Standard Resolution | Active Resolution | | Refresh Rate | Pixel Rate | Aspect Ratio | Stand for Mode |
|---------------------|-------------------|---------|--------------|------------|--------------|--------------------------|
| | H Pixels | V Lines | | | | |
| VGA | 640 | 480 | 60 Hz | 25.175 MHz | 4:3 | Video Graphic Array |
| | | | 72 Hz | 31.5 MHz | | |
| | | | 75 Hz | 31.5 MHz | | |
| WVGA | 720 | 400 | 70 Hz | 33.75 MHz | 16:9 | Wide Video Graphic Array |
| SVGA | 800 | 600 | 60 Hz | 40 MHz | 4:3 | Super VGA |
| | | | 75 Hz | 49.5 MHz | | |
| XGA | 1024 | 768 | 60 Hz | 65 MHz | 4:3 | Extended Graphic Array |
| | | | 75 Hz | 78.75 MHz | | |
| WXGA | 1280 | 768 | 60 Hz | 79.5 MHz | 5:3 | Wide XGA |
| WXGA | 1280 | 800 | 60 Hz | 79.5 MHz | 16:10 | Wide XGA |
| SXGA | 1280 | 960 | 60 Hz | 108 MHz | 4:3 | Super XGA |
| SXGA | 1280 | 1024 | 60 Hz | 108 MHz | 5:4 | Super XGA |
| WXGA | 1360 | 768 | 60 Hz | 85.5 MHz | 16:9 | Wide XGA |
| WXGA | 1366 | 768 | 60 Hz | 85.5 MHz | 16:9 | Wide XGA |
| UXGA | 1600 | 1200 | 60 Hz | 162 MHz | 4:3 | Ultra XGA |
| HD1080 | 1920 | 1080 | 60 Hz | 148.5 MHz | 16:9 | HD1080 |

HD Resolution:

| Standard Resolution | Active Resolution | | Refresh Rate | Pixel Rate | Aspect Ratio | Stand for Mode |
|---------------------|-------------------|---------|--------------|------------|--------------|--------------------|
| | H Pixels | V Lines | | | | |
| 720p | 1280 | 720 | 50 Hz | 74.25 MHz | 16:9 | Normally DVB Mode |
| | | | 60 Hz | | | |
| 1080i | 1920 | 1080 | 25 Hz | 74.25 MHz | 16:9 | Normally ATSC Mode |
| | | | 30 Hz | | | |
| 1080p | 1920 | 1080 | 50 Hz | 148.5 MHz | 16:9 | Normally ATSC Mode |
| | | | 60 Hz | | | |

- The PC text quality is optimum in HD 1080 mode (1920 x 1080, 60Hz).
- Your PC display screen might appear different depending on the manufacturer (and your particular version of Windows).
- Check your PC instruction book for information about connecting your PC to a display.
- If a vertical and horizontal frequency-select mode exists, select 60Hz (vertical) and 31.5KHz (horizontal). In some cases, abnormal signals (such as stripes) might appear on the screen when the PC power is turned off (or if the PC is disconnected). If so, press the [INPUT] button to enter the video mode. Also, make sure that the PC is connected.
- When horizontal synchronous signals seem irregular in RGB mode, check PC power saving mode or cable connections.
- The display settings table complies to the IBM/VESA standards, and based on the analog input.
- The DVI support mode is regarded as same to the PC support mode.
- The best timing for the vertical frequency to each mode is 60Hz.

8. Pixel Defect Policy

We strive to deliver the highest quality products and use some of the industry's most advanced manufacturing processes whilst practicing stringent quality control. However, pixel or sub-pixel defects on the PDP / TFT panels used in Plasma- & LCD- displays are sometimes unavoidable. No manufacturer can guarantee that all panels will be free from pixel defects, but Philips guarantees that any Plasma- & LCD- displays with an unacceptable number of defects will be repaired during the warranty period in line with your local guarantee conditions.

This notice explains the different types of pixel defects and defines the acceptable defect level for the LCD screen. In order to qualify for repair under warranty, the number of pixel defects must exceed a certain level as shown in the reference table. If the LCD screen is within specification a warranty exchange / claim back will be refused. Additionally, because some types or combinations of pixel defects are more noticeable than others, Philips sets even higher quality standards for those.

8.1. Pixels and Sub-Pixels

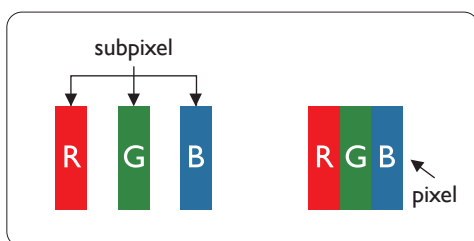

A pixel, or picture element, is composed of three sub-pixels in the primary colors of red, green and blue. Many pixels together form an image. When all sub-pixels of a pixel are lit, the three colored sub-pixels together appear as a single white pixel. When all are dark, the three colored sub-pixels together appear as a single black pixel. Other combinations of lit and dark sub-pixels appear as single pixels of other colors.

8.2. Types of Pixel Defects + Dot Definition

Pixel and sub-pixel defects appear on the screen in different ways. There are three categories of pixel defects and several types of sub-pixel defects within each category.

Dot definition = What is a defective “Dot”? :

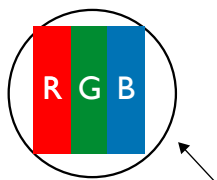

One or more defective, adjacent sub-pixel are defined as one “dot”. The no. of defective sub-pixels are not relevant to define a defective dot. This means that a defective dot can consist of one, two or three defective sub-pixels which can be dark or lit.



One dot = One Pixel; consists of three sub-pixels of Red, Green, and Blue.

8.3. Bright Dot Defects

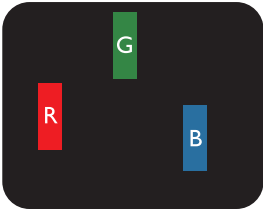
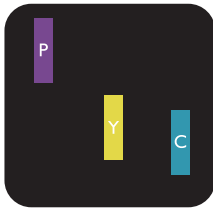
Bright dot defects appear as pixels or sub-pixels that are always lit or “on”. These are the examples of bright dot defects:

| | | |
|---|---|--|
|  <p>One lit red, green or blue sub pixel</p> |  <p>Two adjacent lit sub pixels: Red + Blue = Purple Red + Green = Yellow Green + Blue = Cyan (Light Blue)</p> |  <p>Three adjacent lit sub pixels (one white pixel)</p> |
|---|---|--|

8.4. Dark Dot Defects

Black dot defects appear as pixels or sub-pixels that are always dark or “off”. These are the examples of black dot defects:

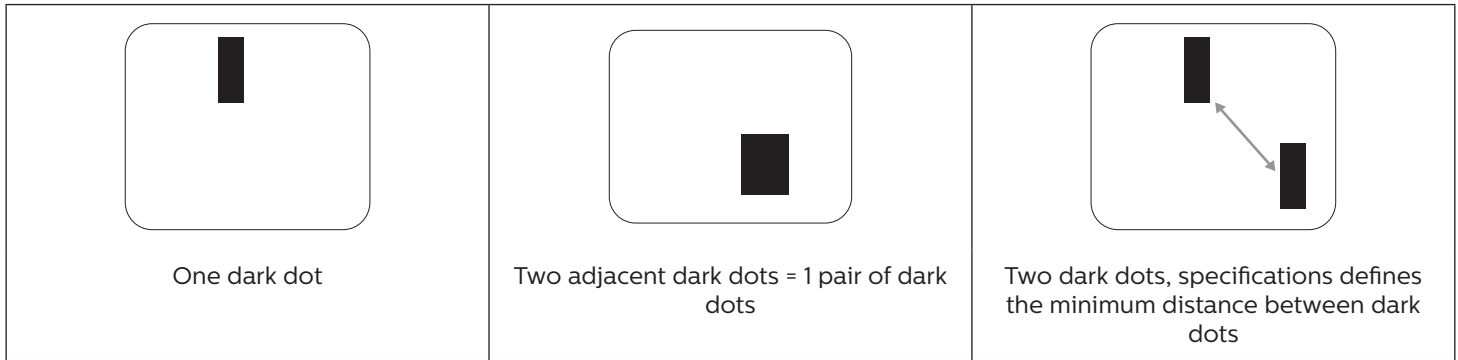

8.5. Proximity of Pixel Defects

Because pixel and sub-pixels defects of the same type that are nearby one another may be more noticeable, Philips also specifies tolerances for the proximity of pixel defects. In the table below you can find specifications about:

- Allowed amount of adjacent dark dots = (adjacent dark dots =1 pair of dark dots)
- Minimum distance between dark dots
- Total no. of all defective dots

8.6. Pixel Defect Tolerances

In order to qualify for repair due to pixel defects during the warranty period, a PDP / TFT panel in a Philips Plasma / LCD-display must have pixel or sub-pixel defects exceeding the tolerances listed in the following table.

| BRIGHT DOT EFFECT | ACCEPTABLE LEVEL |
|--------------------------------|------------------|
| 1 lit sub pixel | 2 |
| BLACK DOT EFFECT | ACCEPTABLE LEVEL |
| 1 dark sub pixel | 10 |
| TOTAL DOT DEFECTS OF ALL TYPES | 12 |

Note: * 1 or 2 adjacent sub pixel defects = 1 dot defect

8.7. MURA

Dark spots or patches may occasionally appear on some liquid crystal display (LCD) panels. This is known within the industry as Mura, which is a Japanese term for “unevenness.” It is used to describe an irregular pattern or area in which uneven screen uniformity appears under certain conditions. Mura is a result of the deterioration of the liquid crystal alignment layer and is most commonly caused by long-term operation under high ambient temperatures. It is an industry- wide phenomenon and Mura is not repairable. It is also not covered by our warranty terms.

Mura has been around since the introduction of LCD technology and with screens getting bigger and in operation 24/7, many displays are running in low light conditions. This all adds to the possibility of Mura affecting displays.

HOW TO SPOT MURA

There are many symptoms of Mura and also multiple causes. Several of these are listed below:

- Impurities or foreign particles in the crystal matrix
- Uneven distribution of LCD matrix during manufacturing
- Non-uniform luminance distribution of the backlight
- Panel assembly induced stress
- Flaws within the LCD cells
- Thermal induced stress - high temperature operation over long periods of time

HOW TO AVOID MURA

Although we can not guarantee the complete eradication of Mura every time, in general the appearance of Mura can be minimized by these methods:

- Lower the backlight brightness
- Use a screen saver
- Reduce the ambient temperature around the unit

9. Cleaning and Troubleshooting

9.1. Cleaning

Caution When Using the Display

- Do not bring your hands, face or objects close to the ventilation holes of the display. The top of the display is usually very hot due to the high temperature of exhaust air being released through the ventilation holes. Burns or personal injuries may occur if any body parts are brought too close. Placing any object near the top of the display could also result in heat related damage to the object as well as the display itself.
- Be sure to disconnect all cables before moving the display. Moving the display with its cables attached may damage the cables and thus cause fire or electric shock.
- Disconnect the power plug from the wall outlet as a safety precaution before carrying out any type of cleaning or maintenance procedure.

Front Panel Cleaning Instructions

- The front of the display has been specially treated. Wipe the surface gently using only a cleaning cloth or a soft, lint-free cloth.
- If the surface becomes dirty, soak a soft, lint-free cloth in a mild detergent solution. Wring the cloth to remove excess liquid. Wipe the surface of the display to remove dirt. Then use a dry cloth of the same type to dry.
- Do not scratch or hit the surface of the panel with fingers or hard objects of any kind.
- Do not use volatile substances such as insert sprays, solvents and thinners.

Cabinet Cleaning Instructions

- If the cabinet becomes dirty, wipe the cabinet with a soft, dry cloth.
- If the cabinet is extremely dirty, soak a lint-free cloth in a mild detergent solution. Wring the cloth to remove as much moisture as possible. Wipe the cabinet. Use another dry cloth to wipe over until the surface is dry.
- Do not use solution that contains oil to clean the plastic parts. Such product damage the plastic parts and void the warranty.
- Do not allow any water or detergent to come into contact with the surface of the display. If water or moisture gets inside the unit, operating problems, electrical and shock hazards may result.
- Do not scratch or hit the cabinet with fingers or hard objects of any kind.
- Do not use volatile substances such as insert sprays, solvents and thinners on the cabinet.
- Do not place anything made from rubber or PVC near the cabinet for any extended periods of time.

9.2. Troubleshooting

| Symptom | Possible Cause | Remedy |
|---|---|---|
| No picture is displayed | <ol style="list-style-type: none"> 1. The power cord is disconnected. 2. The main power switch on the back of the display is not switched on. 3. The selected input has no connection. 4. The display is in standby mode. | <ol style="list-style-type: none"> 1. Plug in the power cord. 2. Make sure the power switch is switched on. 3. Connect a signal connection to the display. |
| Interference displayed on the display or audible noise is heard | Caused by surrounding electrical appliances or fluorescent lights. | Move the display to another location to see if the interference is reduced. |
| Color is abnormal | The signal cable is not connected properly. | Make sure that the signal cable is attached firmly to the back of the display. |
| Picture is distorted with abnormal patterns | <ol style="list-style-type: none"> 1. The signal cable is not connected properly. 2. The input signal is beyond the capabilities of the display. | <ol style="list-style-type: none"> 1. Make sure that the signal cable is attached firmly. 2. Check the video signal source to see if it is beyond the range of the display. Please verify its specifications with this display's specification section. |
| Display image doesn't fill up the full size of the screen | <ol style="list-style-type: none"> 1. The zoom mode is not set correctly. 2. Scan Mode may be set incorrectly to underscan. 3. If the image exceeds the screen size, Scan Mode may need to be set to Underscan. | Use the Zoom mode or Custom zoom function in the Screen menu to fine tune display geometry and time frequency parameter. |
| Can hear sound, but no picture | Source signal cable is connected improperly. | Make sure that both video inputs and sound inputs are correctly connected. |
| Can see picture but no sound is heard | <ol style="list-style-type: none"> 1. Source signal cable is connected improperly. 2. Volume is turned all the way down. 3. {Mute} is turned on. 4. No external speaker connected. | <ol style="list-style-type: none"> 1. Make sure that both video inputs and sound inputs are correctly connected. 2. Press [+] or [-] button to hear sound. 3. Switch MUTE off by using the [MUTE] button. 4. Connect external speakers and adjust the volume to a suitable level. |
| Some picture elements do not light up | Some pixels of the display are off. | This display is manufactured using an extremely high level of precision technology: however, sometimes some pixels of the display may not display. This is not a malfunction. |
| After-Images can still be seen on the display after the display is powered off. (Examples of still pictures include logos, video games, computer images, and images displayed in 4:3 normal mode) | A still picture is displayed for an over extended period of time | Do not allow a still image to be displayed for an extended period of time as this can cause a permanent after-image to remain on the display. |

10. Warranty Statement

Warranty period for PHILIPS signage display is listed as below, for areas not covered in this table, please follow their warranty statement.

| Region | Warranty Period |
|--------------|-----------------|
| USA, Canada | 3 years |
| China | 1 year |
| Asia Pacific | 3 years |
| Europe | 3 years |
| Brazil | 3 years |

11. Technical Specifications

Display:

| Item | Specifications | |
|---------------------------|----------------------------|----------------------------|
| | 55BDL4005X | 55BDL4007X |
| Screen Size (Active Area) | 54.6" (138.7 cm) LCD | 54.6" (138.7 cm) LCD |
| Aspect Ratio | 16:9 | 16:9 |
| Number of pixels | 1920 (H) x 1080 (V) | 1920 (H) x 1080 (V) |
| Pixel pitch | 0.559 (H) x 0.559 (V) [mm] | 0.559 (H) x 0.559 (V) [mm] |
| Displayable colors | 10bit,1.07B colors | 10bit,1.07B colors |
| Brightness (typical) | 500 cd/m ² | 700 cd/m ² |
| Contrast ratio (typical) | 1200:1 | 1200:1 |
| Viewing angle | 178 degrees | 178 degrees |

In/Out Terminals:

| Item | | Specifications |
|----------------------------|--|--|
| Speaker Output | Internal Speakers External Speakers | 10W (L) + 10W (R) [RMS]/8Ω 82 dB / W / M / 160 Hz ~ 13 KHz |
| Audio Output | Phone Jack x 1 | 0.5V [rms] (Normal) / 2 Channel (L+R) |
| Audio Input | RCA Jack x 2 3.5 mm Stereo x 1 | 0.5V [rms] (Normal) / 2 Channel (L+R) |
| RS232 Input/Output | 2.5mm Phone jack x 2 | RS232 in / RS232 out |
| IR Input/Output | 3.5mm Phone jack x 2 | IR in / IR out |
| RJ-45 Input/Output | RJ-45 Jack x 2 (8 pin) | 10/100 LAN Port |
| HDMI Input | HDMI Jack x 2 (Type A) (18 pin) | Digital RGB: TMDS (Video + Audio) MAX: Video - 720p, 1080p, 3840 x 2160/30 Hz Audio - 48 KHz / 2 Channel (L+R) Supports LPCM only |
| DVI-D Input | DVI-D jack | Digital RGB: TMDS (Video) |
| VGA Input | D-Sub Jack x 1 (15 pin) | Analog RGB: 0.7V [p-p] (75Ω), H/CS/V: TTL (2.2kΩ), SOG: 1V [p-p] (75Ω) MAX: 1920 x 1080/60 Hz (FHD) |
| DVI-I (DVI-D & VGA) Output | DVI-I Jack x 1 (29 pin) | Digital RGB: TMDS (Video) Analog RGB: 0.7V [p-p] (75Ω), H/CS/V: TTL (2.2kΩ), SOG: 1V [p-p] (75Ω) MAX: 1920 x 1080/60 Hz (FHD) |
| Component Input | BNC Jack x 3 | Y: 1V [p-p] (75Ω), Pb: 0.7V [p-p] (75Ω), Pr: 0.7V [p-p] (75Ω) MAX: 480i, 576i, 480p, 576p, 720p, 1080i, 1080p |
| Video Input | BNC x 1 (Share with Component_Y) | Composite 1V [p-p] (75Ω) |
| Displayport in/out | Displayport Jack x 2 (20 pin) | Digital RGB: TMDS (Video + Audio) MAX: Video - 720p, 1080p, 3840 x 2160/30Hz Audio - 48 KHz / 2 Channel (L+R) Supports LPCM only |

General:

| Item | Specifications | |
|-----------------------------------|--|--|
| | 55BDL4005X | 55BDL4007X |
| Power Supply | AC 100 - 240V, 50/60Hz | AC 100 - 240V, 50/60Hz |
| Power Consumption (Max) | 280 W | 360 W |
| Power Consumption (Typ.) | 135 W | 165 W |
| Power Consumption (Standby & Off) | <0.5W | <0.5W |
| Dimensions [W x H x D] | 1211.4 x 682.2 x 97.27 mm(D@Wall Mount)/98.42 mm(D@Handle) | 1211.4 x 682.2 x 97.27 mm(D@Wall Mount)/98.42 mm(D@Handle) |
| Weight | 24.87 Kg | 24.87 Kg |
| Gross Weight | 34.3 Kg | 34.3 Kg |
| Energy Efficiency Class | A | B |
| On Mode Power Consumption (W) | 110 W | 113 W |
| Annual Energy Consumption (kWh) | 161 kWh | 165 kWh |
| Standby Power Consumption (W) | <0.50 W | <0.50 W |
| Off Mode Power Consumption (W) | 0 W | 0 W |
| Display Resolution (Pixels) | 1920 x 1080 | 1920 x 1080 |
| Network Standby (W) | 2W | 2W |

Environmental Condition:

| Item | | Specifications |
|-------------|--------------------|-------------------------------|
| Temperature | Operational | 0 ~ 40°C |
| | Storage | -20 ~ 60°C |
| Humidity | Operational | 20 ~ 80% RH (No condensation) |
| | Storage | 5 ~ 95% RH (No condensation) |
| Altitude | Operational | 0 ~ 3,000 m |
| | Storage / Shipment | 0 ~ 9,000 m |



2021 © TOP Victory Investments Ltd. All rights reserved.

This product has been manufactured by and is sold under the responsibility of Top Victory Investments Ltd., and Top Victory Investments Ltd. is the warrantor in relation to this product. Philips and the Philips Shield Emblem are registered trademarks of Koninklijke Philips N.V. and are used under license.

Specifications are subject to change without notice.

Version:V1.00 2021-03-15