

PHILIPS

Professional
Display Solutions

C Line

55BDL6051C/65BDL6051C



www.philips.com/welcome

User Manual (English)

Safety Instructions

Safety precautions and maintenance



WARNING: Use of controls, adjustments or procedures other than those specified in this documentation may result in exposure to shock, electrical hazards and/or mechanical hazards.

Read and follow these instructions when connecting and using your display:

Operation:

- Keep the display out of direct sunlight and away from stoves or any other heat sources.
- Keep the display away from oil, otherwise the plastic cover may be damaged.
- Remove any object that could fall into ventilation holes or prevent proper cooling of the display's electronics.
- Do not block the ventilation holes on the cabinet.
- When positioning the display, make sure the power plug and outlet are easily accessible.
- When turning off the display by detaching the power cord, wait 6 seconds before re-attaching the power cord for normal operation.
- Ensure the use of an approved power cord provided by Philips at all times. If your power cord is missing, please contact your local service center.
- Do not subject the display to severe vibration or high impact conditions during operation.
- Do not knock or drop the display during operation or transportation.
- The eye bolt is for usage in short-time maintenance and installation. We suggest not to use the eye bolt for more than 1 hour. Prolong usage is prohibited. Please keep a clear safety area under the display while using the eye bolt.

Maintenance:

- To protect your display from possible damage, do not put excessive pressure on the LCD panel. When moving your display, grasp the frame to lift; do not lift the display by placing your hand or fingers on the LCD panel.
- Unplug the display if you are not going to use it for an extensive period of time.
- Unplug the display if you need to clean it with a slightly damp cloth. The screen may be wiped with a dry cloth when the power is off. However, never use organic solvent, such as, alcohol, or ammonia-based liquids to clean your display.
- To avoid the risk of shock or permanent damage to the set, do not expose the display to dust, rain, water or an excessively moist environment.
- If your display becomes wet, wipe it with dry cloth as soon as possible.
- If a foreign substance or water gets in your display, turn the power off immediately and disconnect the power cord. Then remove the foreign substance or water, and send the unit to the maintenance center.
- Do not store or use the display in locations exposed to heat, direct sunlight or extreme cold.
- In order to maintain the best performance of your display and ensure a longer lifetime, we strongly recommend using the display in a location that falls within the following temperature and humidity ranges.
 - Temperature: 0-40°C 32-104°F
 - Humidity: 20-80% RH
- LCD panel temperature need to be 25 degrees Celsius at all time for better luminance performance.

IMPORTANT: Always activate a moving screen saver program when you leave your display unattended. Always activate a periodic screen refresh application if the unit will display unchanging static content. Uninterrupted display of still or static images over an extended period may cause “burn in”, also known as “after-imaging” or “ghost imaging”, on your screen. This is a well-known phenomenon in LCD panel technology. In most cases, the “burned in” or “after-imaging” or “ghost imaging” will disappear gradually over a period of time after the power has been switched off.

WARNING: Severe “burn-in” or “after-image” or “ghost image” symptoms will not disappear and cannot be repaired. This is also not covered under the terms of your warranty.

Service:

- The casing cover should be opened only by qualified service personnel.
- If there is any need for repair or integration, please contact your local service center.
- Do not leave your display under direct sunlight.



If your display does not operate normally, having followed the instructions set out in this document, please contact a technician or your local service center.

Stability Hazard

The device may fall, causing serious personal injury or death. To prevent injury, this device must be securely attached to the floor/wall in accordance with the installation instructions.

Read and follow these instructions when connecting and using your display:



- Unplug the display if you are not going to use it for an extensive period of time.
- Unplug the display if you need to clean it with a slightly damp cloth. The screen may be wiped with a dry cloth when the power is off. However, never use alcohol, solvents or ammonia-based liquids.
- Consult a service technician if the display does not operate normally when you have followed the instructions in this manual.
- The casing cover should be opened only by qualified service personnel.
- Keep the display out of direct sunlight and away from stoves or any other heat sources.
- Remove any object that could fall into the vents or prevent proper cooling of the display's electronics.
- Do not block the ventilation holes on the cabinet.
- Keep the display dry. To avoid electric shock, do not expose it to rain or excessive moisture.
- When turning off the display by detaching the power cable or DC power cord, wait for 6 seconds before re-attaching the power cable or DC power cord for normal operation..
- To avoid the risk of shock or permanent damage to the set do not expose the display to rain or excessive moisture.
- When positioning the display, make sure the power plug and outlet are easily accessible.
- **IMPORTANT:** Always activate a screen saver program during your application. If a still image in high contrast remains on the screen for an extended period of time, it may leave an 'after-image' or 'ghost image' on the front of the screen. This is a well-known phenomenon that is caused by the shortcomings inherent in LCD technology. In most cases the afterimage will disappear gradually over a period of time after the power has been switched off. Be aware that the after-image symptom cannot be repaired and is not covered under warranty.
- If provided with a 3-pin attachment plug on the power cord, plug the cord into a grounded (earthed) 3-pin outlet. Do not disable the power cord grounding pin, for example, by attaching a 2-pin adapter. The grounding pin is an important safety feature.

EU Declaration of Conformity

This device complies with the requirements set out in the Council Directive on the Approximation of the Laws of the Member States relating to Electromagnetic Compatibility (2014/30/EU), Low-voltage Directive (2014/35/EU), RoHS directive (2011/65/EU), ErP directive (2009/125/EC).

This product has been tested and found to comply with the harmonized standards for Information Technology Equipment, these harmonized standards published under Directives of Official Journal of the European Union.

ESD Warnings

When user close to the monitor may cause the equipment discharge and reboot to the display of main menu.

Warning:

This equipment is compliant with Class A of EN55032/CISPR 32. In a residential environment this equipment may cause radio interference.

Federal Communications Commission (FCC) Notice (U.S. Only)



NOTE: This equipment has been tested and found to comply with the limits for a Class A digital device, pursuant to part 15 of the FCC Rules. These limits are designed to provide reasonable protection against harmful interference when the equipment is operated in a commercial environment. This equipment generates, uses, and can radiate radio frequency energy and, if not installed and used in accordance with the instruction manual, may cause harmful interference to radio communications. Operation of this equipment in a residential area is likely to cause harmful interference in which case the user will be required to correct the interference at his own expense.



Changes or modifications not expressly approved by the party responsible for compliance could void the user's authority to operate the equipment.

Use only an RF shielded cable that was supplied with the display when connecting this display to a computer device. To prevent damage which may result in fire or shock hazard, do not expose this appliance to rain or excessive moisture.

This device complies with Part 15 of the FCC / ISED's licence-exempt RSSs Rules. Operation is subject to the following two conditions: (1) This device may not cause harmful interference, and (2) this device must accept any interference received, including interference that may cause undesired operation.

Le présent appareil est conforme aux CNR d'ISED applicables aux appareils radio exempts de licence. L'exploitation est autorisée aux deux conditions suivantes : (1) le dispositif ne doit pas produire de brouillage préjudiciable, et (2) ce dispositif doit accepter tout brouillage reçu, y compris un brouillage susceptible de provoquer un fonctionnement indésirable.

Envision Peripherals Inc.
490 N McCarthy Blvd, Suite #120
Milpitas, CA 95035
USA

Europe Statement

IMPORTANT NOTE:

The device is restricted to indoor use only when operating in the 5150 to 5350MHz frequency range. (for 5G product only)

	AT	BE	BG	HR	CY	CZ	DK
	EE	FI	FR	DE	EL	HU	IE
	IT	LV	LT	LU	MT	NL	PL
	PT	RO	SK	SI	ES	SE	UK(NI)
	UK						

Radiation Exposure Statement:

This equipment complies with CE radiation exposure limits set forth for an uncontrolled environment. This equipment should be installed and operated with minimum distance 20cm between the radiator & body.

The frequency, mode and the maximum transmitted power in EU are listed below:

2400-2483.5MHz: < 20 dBm (EIRP) (for 2.4G product only)

5150-5250MHz: < 23 dBm (EIRP)

5250-5350MHz: < 23 dBm (EIRP)

5470-5725MHz: < 30 dBm (EIRP)

5725-5825MHz: < 13.98 dBm (EIRP)

Taiwan:**低功率電波輻射性電機管理辦法**

取得審驗證明之低功率射頻器材，非經核准，公司、商號或使用者均不得擅自變更頻率、加大功率或變更原設計之特性及功能。

低功率射頻器材之使用不得影響飛航安全及干擾合法通信；經發現有干擾現象時，應立即停用，並改善至無干擾時方得繼續使用。

前述合法通信，指依電信管理法規定作業之無線電通信。低功率射頻器材須忍受合法通信或工業、科學及醫療用電波輻射性電機設備之干擾。

FCC/ISED/CE-RED Caution:

Any changes or modifications not expressly approved by the party responsible for compliance could void the user's authority to operate this equipment.

This transmitter must not be co-located or operating in conjunction with any other antenna or transmitter.

Operations in the 5GHz products are restricted to indoor usage only.

Déclaration d'exposition aux radiations:

Cet équipement est conforme aux limites d'exposition aux rayonnements ISED établies pour un environnement non contrôlé. Cet équipement doit être installé et utilisé avec un minimum de 20cm de distance entre la source de rayonnement et votre corps.

Canada:

Industry Canada statement:

This device complies with RSS-247 of the Industry Canada Rules. Operation is subject to the following two conditions: (1) This device may not cause harmful interference, and (2) this device must accept any interference received, including interference that may cause undesired operation.

Ce dispositif est conforme à la norme CNR-247 d'Industrie Canada applicable aux appareils radio exempts de licence. Son fonctionnement est sujet aux deux conditions suivantes: (1) le dispositif ne doit pas produire de brouillage préjudiciable, et (2) ce dispositif doit accepter tout brouillage reçu, y compris un brouillage susceptible de provoquer un fonctionnement indésirable.

Radiation Exposure Statement:

This equipment complies with FCC/ISED/CE-RED radiation exposure limits set forth for an uncontrolled environment. This equipment should be installed and operated with minimum distance 20cm between the radiator & your body.

Déclaration d'exposition aux radiations:

Cet équipement est conforme aux limites d'exposition aux rayonnements ISED établies pour un environnement non contrôlé. Cet équipement doit être installé et utilisé avec un minimum de 20 cm de distance entre la source de rayonnement et votre corps.

Polish Center for Testing and Certification Notice

The equipment should draw power from a socket with an attached protection circuit (a three-prong socket). All equipment that works together (computer, display, printer, and so on) should have the same power supply source.

The phasing conductor of the room's electrical installation should have a reserve short-circuit protection device in the form of a fuse with a nominal value no larger than 16 amperes (A).

To completely switch off the equipment, the power supply cable must be removed from the power supply socket, which should be located near the equipment and easily accessible.

A protection mark "B" confirms that the equipment is in compliance with the protection usage requirements of standards PN-93/T-42107 and PN-89/E-06251.

Wymagania Polskiego Centrum Badań i Certyfikacji

Urządzenie powinno być zasilane z gniazda z przyłączonym obwodem ochronnym (gniazdo z kolkiem). Współpracujące ze sobą urządzenia (komputer, monitor, drukarka) powinny być zasilane z tego samego źródła.

Instalacja elektryczna pomieszczenia powinna zawierać w przewodzie fazowym rezerwową ochronę przed zwarciami, w postaci bezpiecznika o wartości znamionowej nie większej niż 16A (amperów).

W celu całkowitego wyłączenia urządzenia z sieci zasilania, należy wyjąć wtyczkę kabla zasilającego z gniazdka, które powinno znajdować się w pobliżu urządzenia i być łatwo dostępne.

Znak bezpieczeństwa "B" potwierdza zgodność urządzenia z wymaganiami bezpieczeństwa użytkowania zawartymi w PN-93/T-42107 i PN-89/E-06251.

Pozostałe instrukcje bezpieczeństwa

- Nie należy używać wtyczek adapterowych lub usuwać kolka obwodu ochronnego z wtyczki. Jeżeli konieczne jest użycie przedłużacza to należy użyć przedłużacza 3-żyłowego z prawidłowo połączonym przewodem ochronnym.
- System komputerowy należy zabezpieczyć przed nagłymi, chwilowymi wzrostami lub spadkami napięcia, używając eliminatora przepięć, urządzenia dopasowującego lub bezzakłócenowego źródła zasilania.
- Należy upewnić się, aby nic nie leżało na kablach systemu komputerowego, oraz aby kable nie były umieszczone w miejscu, gdzie można byłoby na nie nadeptywać lub potykać się o nie.
- Nie należy rozlewać napojów ani innych płynów na system komputerowy.
- Nie należy wpychać żadnych przedmiotów do otworów systemu komputerowego, gdyż może to spowodować pożar lub porażenie prądem, poprzez zwarcie elementów wewnętrznych.
- System komputerowy powinien znajdować się z dala od grzejników i źródeł ciepła. Ponadto, nie należy blokować otworów wentylacyjnych. Należy unikać kładzenia luźnych papierów pod komputer oraz umieszczania komputera w ciasnym miejscu bez możliwości cyrkulacji powietrza wokół niego.

Electric, Magnetic and Electromagnetic Fields ("EMF")

1. We manufacture and sell many products targeted at consumers, which, like any electronic apparatus, in general have the ability to emit and receive electromagnetic signals.
2. One of our leading Business Principles is to take all necessary health and safety measures for our products, to comply with all applicable legal requirements and to stay well within the EMF standards applicable at the time of producing the products.
3. We are committed to develop, produce and market products that cause no adverse health effects.
4. We confirm that if its products are handled properly for their intended use, they are safe to use according to scientific evidence available today.
5. We play an active role in the development of international EMF and safety standards, enabling us to anticipate further developments in standardization for early integration in its products.

Information for U.K. only

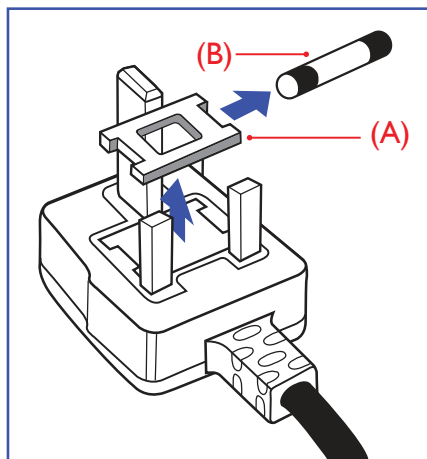

WARNING - THIS APPLIANCE MUST BE EARTHED.

Important:

This apparatus is supplied with an approved moulded 13A plug. To change a fuse in this type of plug proceed as follows:+

1. Remove fuse cover and fuse.
2. Fit new fuse which should be a BS 1362 5A, A.S.T.A. or BSI approved type.
3. Refit the fuse cover.

If the fitted plug is not suitable for your socket outlets, it should be cut off and an appropriate 3-pin plug fitted in its place.

If the mains plug contains a fuse, this should have a value of 5A. If a plug without a fuse is used, the fuse at the distribution board should not be greater than 5A.

NOTE: The severed plug must be destroyed to avoid a possible shock hazard should it be inserted into a 13A socket elsewhere.

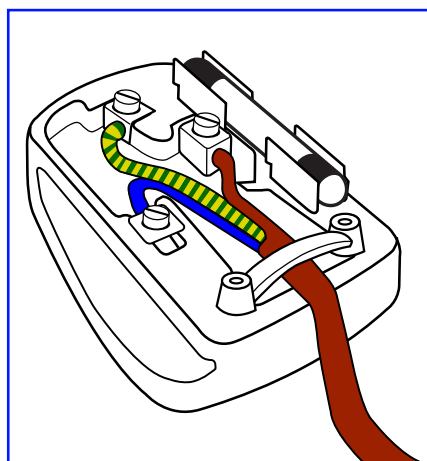

How to connect a plug

The wires in the mains lead are coloured in accordance with the following code:

BLUE - "NEUTRAL" ("N")

BROWN - "LIVE" ("L")

GREEN & YELLOW - "EARTH" ("E")

1. The GREEN & YELLOW wire must be connected to the terminal in the plug which is marked with the letter "E" or by the Earth symbol or coloured GREEN or GREEN & YELLOW.
2. The BLUE wire must be connected to the terminal which is marked with the letter "N" or coloured BLACK.
3. The BROWN wire must be connected to the terminal which marked with the letter "L" or coloured RED.

Before replacing the plug cover, make certain that the cord grip is clamped over the sheath of the lead - not simply over the three wires.

North Europe (Nordic Countries) Information

Placering/Ventilation

VARNING:

FÖRSÄKRA DIG OM ATT HUVUDBRYTARE OCH UTTAG ÄR LÄTÅTKOMLIGA, NÄR DU STÄLLER DIN UTRUSTNING PÅ PLATS.

Placering/Ventilation

ADVARSEL:

SØRG VED PLACERINGSFOR, AT NETLEDNINGENS STIK OG STIKKONTAKT ER NEMT TILGÆNGLIGE.

Paikka/Ilmankierto

VAROITUS:

SIJOITA LAITE SITEN, ETTÄ VERKKOJOHTO VOIDAAN TARVITTAESSA HELPOSTI IRROTTAA PISTORASIESTA.

Plassering/Ventilasjon

ADVARSEL:

NÅR DETTE UTSTYRET PLASSERES, MÅ DU PASSE PÅ AT KONTAKTENE FOR STØMTILFØRSEL ER LETTE Å NÅ.

China RoHS

根据中国大陆《电器电子产品有害物质限制使用管理办法》，以下部分列出了本产品中可能包含的有害物质的名称和含量。

部件名称	有害物质					
	铅 (Pb)	汞 (Hg)	镉 (Cd)	六价铬 (Cr (VI))	多溴联苯 (PBB)	多溴二苯醚 (PBDE)
外壳	○	○	○	○	○	○
液晶显示屏	X	○	○	○	○	○
电路板组件*	X	○	○	○	○	○
电源适配器	X	○	○	○	○	○
电源线/连接线	X	○	○	○	○	○
遥控器	X	○	○	○	○	○

本表格依据SJ/T 11364 的规定编制。

*: 电路板组件包括印刷电路板及其构成的零部件，如电阻、电容、集成电路、连接器等。

○: 表示该有害物质在该部件所有均质材料中的含量均在 GB/T 26572规定的限量要求以下。

X: 表示该有害物质至少在该部件的某一均质材料中的含量超出GB/T 26572规定的限量要求。

上表中打“X”的部件，应功能需要，部分有害物质含量超出GB/T 26572规定的限量要求，但符合欧盟RoHS法规要求（属于豁免部分）。

备注：上表仅做为范例，实际标示时应依照各产品的实际部件及所含有害物质进行标示。



环保使用期限

此标识指期限（十年），电子电气产品中含有的有害物质在正常使用的条件下不会发生外泄或突变，电子电气产品用户使用该电子电气产品不会对环境造成严重污染或对其人身、财产造成严重损害的期限。

《废弃电器电子产品回收处理管理条例》提示性说明

为了更好地关爱及保护地球，当用户不再需要此产品或产品寿命终止时，请遵守国家废弃电器电子产品回收处理相关法律法规，将其交给当地具有国家认可的回收处理资质的厂商进行回收处理，不当利用或者处置可能会对环境和人类健康造成影响。

警告

此为 A 级产品。在生活环境中，该产品可能会造成无线电干扰。在这种情况下，可能需要用户对干扰采取切实可行的措施。

單元	限用物質及其化學符號					
	鉛 (Pb)	汞 (Hg)	鎘 (Cd)	六價鉻 (Cr ⁺⁶)	多溴聯苯 (PBB)	多溴二苯醚 (PBDE)
塑料外框	○	○	○	○	○	○
後殼	○	○	○	○	○	○
液晶面板	—	○	○	○	○	○
電路板組件	—	○	○	○	○	○
底座（選配）	○	○	○	○	○	○
電源線	—	○	○	○	○	○
其他線材	—	○	○	○	○	○
遙控器	—	○	○	○	○	○
喇叭（選配）	—	○	○	○	○	○
風扇（選配）	—	○	○	○	○	○

備考1. “○” 係指該項限用物質之百分比含量未超出百分比含量基準值。
備考2. “—” 係指該項限用物質為排除項目。

警語：使用過度恐傷害視力。

注意事項：

- (1) 使用30分鐘請休息10分鐘。
- (2) 未滿2歲幼兒不看螢幕，2歲以上每天看螢幕不要超過1小時。

警告使用者：

此為甲類資訊技術設備，於居住環境中使用時，可能會造成射頻擾動，在此種情況下，使用者會被要求採取某些適當的對策。

Turkey RoHS:

Türkiye Cumhuriyeti: EEE Yönetmeliğine Uygundur

Ukraine RoHS:

Обладнання відповідає вимогам Технічного регламенту щодо обмеження використання деяких небезпечних речовин в електричному та електронному обладнанні, затвердженого постановою Кабінету Міністрів України від 3 грудня 2008 № 1057

End-of-Life Disposal

Your new Public Information Display contains materials that can be recycled and reused. Specialized companies can recycle your product to increase the amount of reusable materials and to minimize the amount to be disposed of.

Please find out about the local regulations on how to dispose of your old display from your local Philips dealer.

(For customers in Canada and U.S.A.)

This product may contain lead and/or mercury. Dispose of in accordance to local-state and federal regulations. For additional information on recycling contact www.eia.org (Consumer Education Initiative)

Waste Electrical and Electronic Equipment-WEEE

Attention users in European Union private households



This marking on the product or on its packaging illustrates that, under European Directive 2012/19/EU governing used electrical and electronic appliances, this product may not be disposed of with normal household waste. You are responsible for disposal of this equipment through a designated waste electrical and electronic equipment collection. To determine the locations for dropping off such waste electrical and electronic, contact your local government office, the waste disposal organization that serves your household or the store at which you purchased the product.

Attention users in United States:

Please dispose of according to all Local, State and Federal Laws. For the disposal or recycling information, contact: www.mygreenelectronics.com or www.eiae.org.

End of Life Directives-Recycling



Your new Public Information Display contains several materials that can be recycled for new users.

Please dispose of according to all Local, State, and Federal laws.

Restriction on Hazardous Substances statement (India)

This product complies with the "E-Waste (Management) Rules, 2016" CHAPTER V, rule 16, sub-rule (1) . Whereas New Electrical and Electronic Equipment and their components or consumables or parts or spares do not contain Lead, Mercury, Cadmium, Hexavalent Chromium, polybrominated biphenyls and polybrominated diphenyl ethers beyond a maximum concentration value of 0.1% by weight in homogenous materials for lead, mercury, hexavalent chromium, polybrominated biphenyls and polybrominated diphenyl ethers and of 0.01% by weight in homogenous materials for cadmium. except of exemptions set in Schedule 2 of the Rule.

E-Waste Declaration for India



This symbol on the product or on its packaging indicates that this product must not be disposed of with your other household waste. Instead it is your responsibility to dispose of your waste equipment by handing it over to a designated collection point for the recycling of waste electrical and electronic equipment . The separate collection and recycling of your waste equipment at the time of disposal will help to conserve natural resources and ensure that it is recycled in a manner that protects human health and the environment. For more information about E -waste please visit <http://www.india.philips.com/about/sustainability/recycling/index.page> and to know where you can drop off your waste equipment for recycling in India please contact on below given contact details.

Helpline number: 1800-425-6396 (Monday to Saturday, 9 a.m. to 5:30 pm)

E-mail: india.callcentre@tpv-tech.com

Batteries



For EU: The crossed-out wheeled bin implies that used batteries should not be put to the general household waste! There is a separate collection system for used batteries, to allow proper treatment and recycling in accordance with legislation.

Please contact your local authority for details on the collection and recycling schemes.

For Switzerland: The used battery is to be returned to the selling point.

For other non-EU countries: Please contact your local authority for correct method of disposal of the used battery.

According to EU directive 2006/66/EC, the battery can't be disposed improperly. The battery shall be separated to collect by local service.

	<p>Após o uso, as pilhas e/ou baterias deverão ser entregues ao estabelecimento comercial ou rede de assistência técnica autorizada.</p>
--	--

Information for EAC	
Month and year of manufacturing	please refer information in Rating label.
Name and location of manufacturer	ООО "Профтехника" Адрес: 3-й Проезд Марьиной роши, 40/1 офис 1. Москва, 127018, Россия
Importer and information	Наименование организации: ООО "Профтехника" Адрес: 3-й Проезд Марьиной роши, 40/1 офис 1. Москва, 127018, Россия Контактное лицо: Наталья Астафьева, +7 495 640 20 20 nat@profdisplays.ru

Information for FAC:

"Подтверждение соответствия Мининформсвязи России: Декларация соответствия № Д-РД-4342 от 01.09.2016 года, действительна до 01.09.2024 года, зарегистрирована в Федеральном агенстве связи 14.09.2016 года"

Table Of Contents

1.	Unpacking and Installation	1	4.4.1.	OSD menu interaction with media player:	20
1.1.	Package Contents	1	4.4.2.	Media Player introduction:	20
1.2.	Installation Notes.....	1	4.5.	CMND & Play.....	23
1.3.	Mounting on a Wall	2	4.6.	Side Bar	24
1.3.1.	VESA Grid	2	5.	Setting.....	24
2.	Parts and Functions.....	3	5.1.	Network & internet	24
2.1.	Control Panel.....	3	5.2.	Signage Display	25
2.2.	Input/Output Terminals.....	4	5.2.1.	General Settings	25
2.2.1.	Inserting the batteries in the remote control.....	5	5.2.2.	Server Settings	25
2.2.2.	Handling the remote control	5	5.2.3.	Source Settings	25
2.2.3.	Operating range of the remote control.....	5	5.2.4.	System Tools	25
2.2.4.	Using the remote sensor and power indicator	6	5.3.	App & notifications.....	27
2.3.	Remote Control.....	7	5.4.	Display.....	27
2.3.1.	General functions.....	7	5.5.	System.....	27
2.3.2.	ID Remote Control	8	5.6.	Quick Info	28
2.3.3.	Remote Control buttons on Android source.....	9	6.	OSD Menu	28
2.4.	USB Cover.....	11	6.1.	Navigating the OSD Menu	28
2.5.	4G Module.....	12	6.1.1.	Navigating the OSD menu using the remote control	28
3.	Connecting External Equipment	13	6.1.2.	Navigating the OSD menu using the display's control buttons.....	28
3.1.	Connecting External Equipment (DVD/VCR/VCD).....	13	6.2.	OSD Menu Overview.....	29
3.1.1.	Using HDMI video input.....	13	6.2.1.	Picture menu	29
3.2.	Connecting a PC.....	13	6.2.2.	Screen menu	29
3.2.1.	Using DVI input	13	6.2.3.	Audio menu	30
3.2.2.	Using HDMI input	13	6.2.4.	Configuration menu	31
3.2.3.	Using DisplayPort input	13	6.2.5.	Advanced menu.....	32
3.3.	Connecting Audio Equipment	14	6.2.6.	Android Settings.....	34
3.3.1.	Connecting an external audio device.....	14	7.	Supported Media Formats	35
3.4.	Connecting Multiple Displays in a Daisy-chain Configuration.....	14	8.	Input Mode.....	37
3.4.1.	Display control connection.....	14	9.	Pixel Defect Policy	39
3.4.2.	Digital video connection.....	14	9.1.	Pixels and Sub-Pixels	39
3.5.	IR connection.....	15	9.2.	Types of Pixel Defects + Dot Definition	39
3.6.	IR Pass-through Connection	16	9.3.	Bright Dot Defects.....	39
3.7.	Touch Operation.....	17	9.4.	Dark Dot Defects	40
4.	Operation	19	9.5.	Proximity of Pixel Defects.....	40
4.1.	Watch the Connected Video Source	19	9.6.	Pixel Defect Tolerances	40
4.2.	Change Picture Format.....	19	9.7.	MURA.....	40
4.3.	Launcher	19	10.	Cleaning and Troubleshooting.....	41
4.4.	Media Player.....	20	10.1.	Cleaning	41
			10.2.	Troubleshooting.....	42
			11.	Warranty Statement	44
			12.	Technical Specifications.....	45

1. Unpacking and Installation

Before installing the display

- This product is packed in a carton, together with the standard accessories.
- Any other optional accessories will be packed separately.
- Move the display by at least two (2) adults.
- After opening the carton, ensure that the contents are complete and in good condition.

1.1. Package Contents

Please verify that you received the following items with your package content:

- LCD display
- Quick start guide
- Remote Control and AAA batteries
- Power cable
- RS232 cable
- RS232 daisy chain cable
- IR sensor cable
- HDMI cable
- DVI cable
- Touch USB
- Touch Pen
- Philips logo plate
- Cleaning cloth
- USB Cover

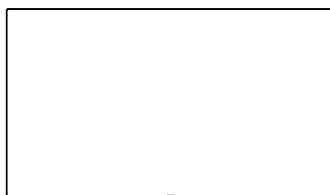

LCD Display



Quick start guide

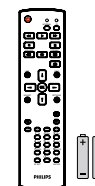

Remote Control and AAA Batteries

* The supplied power cord varies depending on destination.



Power Cord

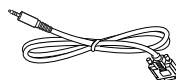

RS232 Cable

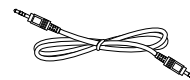

RS232 Daisy Chain Cable



IR Sensor Cable



HDMI Cable



DVI Cable

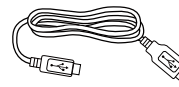

Touch USB



Touch pen



Philips logo plate



Cleaning cloth



USB Cover

* Items may differ in different locations

* Display design and accessories may differ from the images shown.

NOTES:

- For all other regions, apply a power cord that conforms to the AC voltage of the power socket and has been approved by and complies with the safety regulations of the particular country (Type H05W-F, 2G or 3G, 0.75 or 1 mm² should be used).
- Keep the packaging materials appropriately after unpacking the product.

1.2. Installation Notes

- Only use the power cable provided with this product. If an extension cord is required, please consult your service agent.
- The product should be installed on a flat surface, or the product may tip over. Leave a space between the rear of the product and the wall for proper ventilation. Do not install the product in a kitchen, bathroom or a place exposed to moisture, failure to do so may shorten the life of the internal parts.
- Do not install the product where it is 3000m and higher in altitude. Failure to do so may result in malfunctions.

1.3. Mounting on a Wall

To mount this display on a wall, a standard wall-mounting kit (commercially available) is required. It is recommended that you use a mounting interface that complied with TUV-GS and /or UL1678 standard in North America.

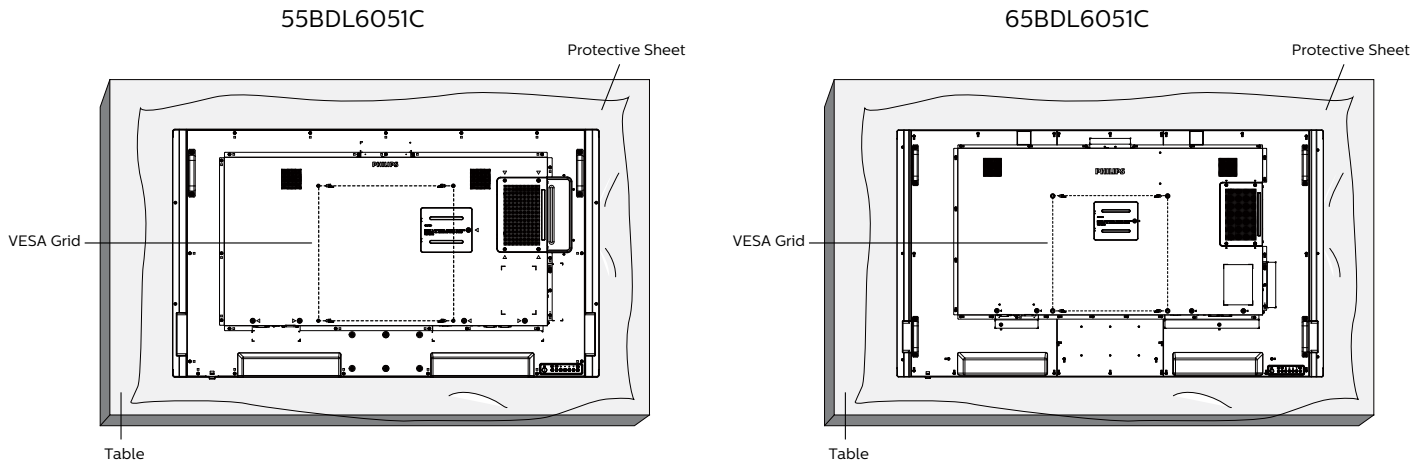

1. Prepare a flat and horizontal surface that is larger than the display and spread a thick protective sheet on it to facilitate your operation without scratching the screen.
2. Ensure you have all accessories for all types of mounting (wall mount, ceiling mount, table stand, etc).
3. Follow the instructions that came with the base mounting kit. Failure to follow the correct mounting procedures could result in damage to the equipment, or injury to the user or installer. The product warranty does not cover the damage caused by improper installation.
4. 55BDL6051C: For the wall-mounting kit, use the M6 mounting screws (with a length 10 mm longer than the thickness of the mounting bracket) and tighten them securely.
5. 65BDL6051C: For the wall-mounting kit, use the M8 mounting screws (with a length 32 mm longer than the thickness of the mounting bracket) and tighten them securely.

1.3.1. VESA Grid

55BDL6051C	400(H) x 400(V) mm
65BDL6051C	400(H) x 400(V) mm

Caution:

To prevent the display from falling:

- For wall or ceiling mounting, we recommend that you install the display with metal brackets which are commercially available. For detailed instructions about the installation, refer to the guide provided with the bracket.
- To prevent the display from falling in case of earthquake or other natural disaster, please consult the manufacturer of the bracket for the mounting location.
- As this product is high and heavy, the installation of this product is recommended to be performed by four technicians.

Required space for ventilation

Leave a space of 100 mm at the top, rear, right and left of the display for ventilation.

NOTE: We recommend you contact a professional technician when installing the display on a wall. We are not responsible for any damage to the product if the installation is not performed by a professional technician.

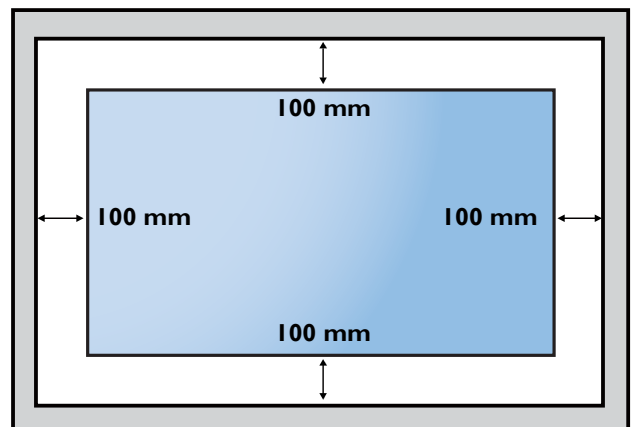

2. Parts and Functions

2.1. Control Panel

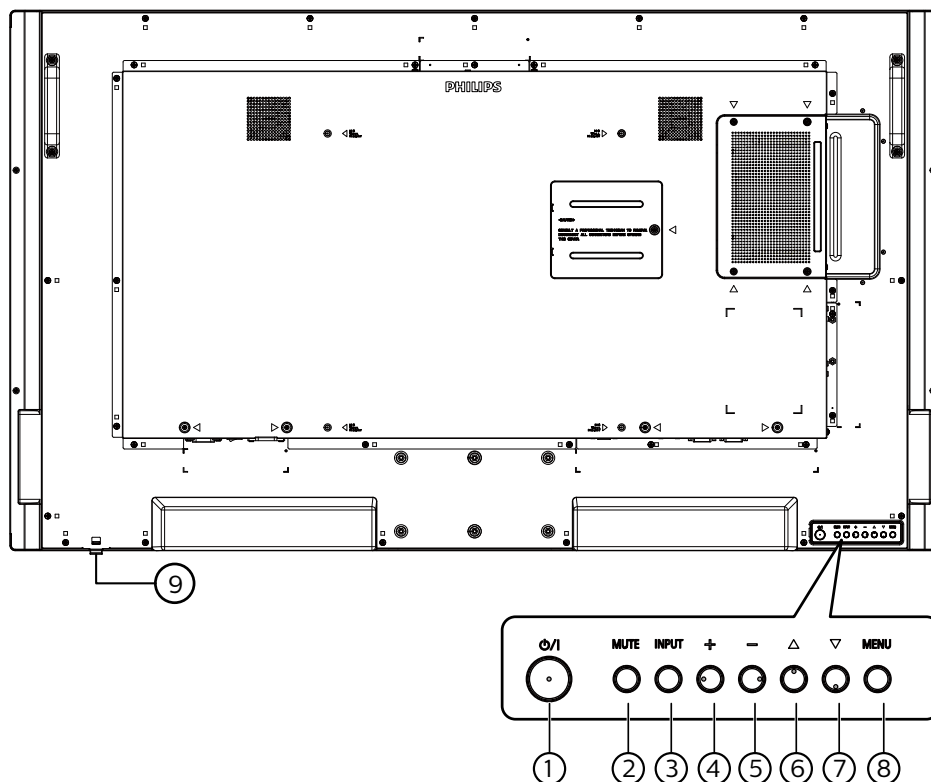

① [⏻/⏻] button

Turn the display On or put the display to standby mode.

② [MUTE] button

Mute the sound or reactivate sound.

③ [INPUT] button

Select an input source.

④ [+] button

Increase the adjustment while OSD menu is On, or increase the audio output level while OSD menu is Off.

⑤ [-] button

Decrease the adjustment while OSD menu is On, or decrease the audio output level while OSD menu is Off.

⑥ [▲] button

Move the selected item one level up while the OSD menu is On.

⑦ [▼] button

Move the selected item one level down while the OSD menu is On.

⑧ [MENU] button

Return to the previous menu while the OSD menu is On. This button can also be used to activate the OSD menu when the OSD menu is Off.

⑨ Remote control sensor and power status indicator

- Receive command signals from the remote control.
- Indicate the operating status of the display:
 - Light green when the display is turned On
 - Light red when the display is in the standby mode
 - When {SCHEDULE} is enabled, the light blinks green and red
 - If the light blinks red, it indicates that a failure has been detected
 - Lights off when the main power of the display is turned off

*** Use an IR sensor cable for better remote control performance. (Please refer to the instructions on 3.5)**

2.2. Input/Output Terminals

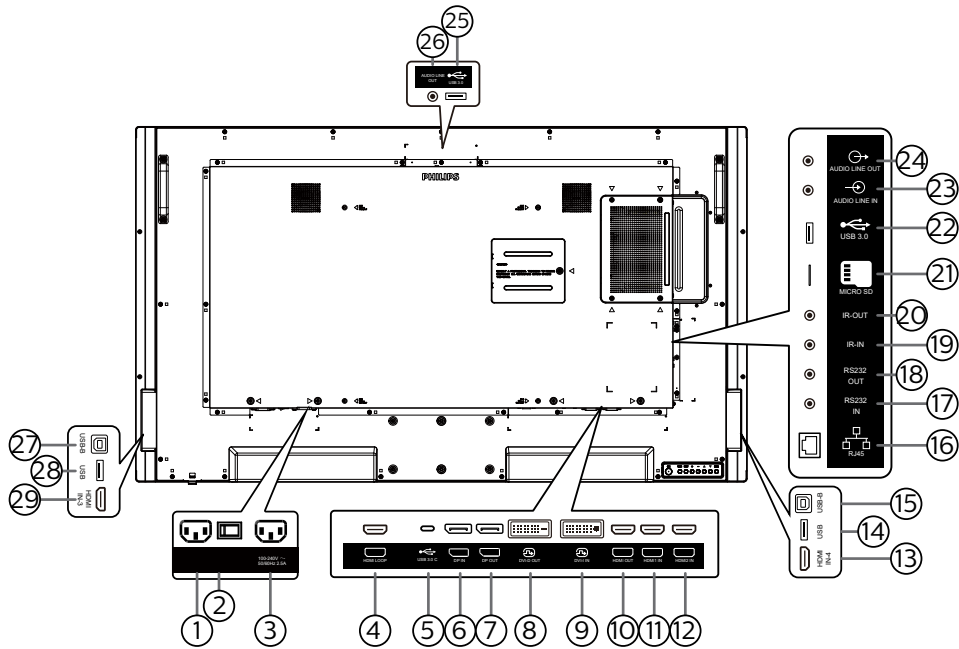

① AC IN

AC power input from the wall outlet.

② MAIN POWER SWITCH

Switch the main power between On and Off.

③ AC OUT

AC power supply to the AC IN jack of a media player.

④ HDMI LOOP

Screen out to next monitor by HDMI.

⑤ USB 3.0 C

Support display and touch function.

⑥ DisplayPort IN / ⑦ DisplayPort OUT

DisplayPort video input/output.

⑧ DVI-D OUT / ⑨ DVI-I IN

DVI video output/input.

⑩ HDMI OUT

Connect to a sink device via an HDMI cable.

⑪ HDMI1 IN / ⑫ HDMI2 IN / ⑬ HDMI4 IN

Connect to a source device via an HDMI cable.

⑭ USB

Connect to external PC to support touch function.

⑮ USB-B

Touch connector to PC.

⑯ RJ-45

The LAN control function is used for sending the remote control signal from the control center in order to install the optional OPS module.

⑰ RS232 IN / ⑱ RS232 OUT

Android RS232 network input/output is reserved for customized protocol usage from System Integrator.

⑲ IR IN / ⑳ IR OUT

IR signal input/output for the loop-through function.

NOTES:

- The remote control sensor of this display will stop working if the jack [IR IN] is connected.
- To remotely control your A/V device via this display, refer to page 16 for IR Pass Through connection.

㉑ MICRO SD

Insert a Micro SD card.

㉒ Android USB 3.0 In

Android USB3.0 Input.

㉓ AUDIO IN

Audio input for VGA source (3.5mm stereo phone).

㉔ AUDIO OUT

Audio output for external AV device.

㉕ USB 3.0

Connect to a USB 3.0 storage device.

㉖ AUDIO OUT

Audio output for external AV device.

㉗ USB-B

Connect to external PC to support touch function.

㉘ USB

Connect to a USB storage device.

㉙ HDMI3 IN

Connect to a source device via an HDMI cable.

2.2.1. Inserting the batteries in the remote control

The remote control is powered by two 1.5V AAA batteries.

To install or replace the batteries:

1. Press and then slide the cover to open it.
2. Insert the batteries with the correct polarity (+) and (-).
3. Replace the cover.

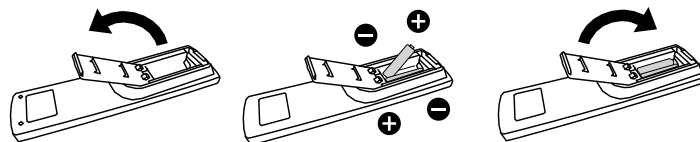

Caution:

Incorrect use of batteries may cause leakage or explosion. Be sure to follow the instructions below:

- Insert “AAA” batteries with the correct polarity (+ and -).
- Do not mix battery types.
- Do not use a new battery with a used one together. Otherwise, it may cause leakage or shorten the life of the batteries.
- Remove the dead batteries immediately to avoid battery leakage in the battery compartment. Do not touch exposed battery acid, as it may cause injury to your skin.
- Disposal of a battery into fire or a hot oven, or mechanically crushing or cutting of a battery, that can result in an explosion; leaving a battery in an extremely high temperature surrounding environment that can result in an explosion or the leakage of flammable liquid or gas; and a battery subjected to extremely low air pressure that may result in an explosion or the leakage of flammable liquid or gas.

NOTE: Remove the batteries from the battery compartment when not using for an extended period of time.

2.2.2. Handling the remote control

- Do not drop or apply shock to the remote control.
- Do not allow any liquid to get inside the remote control. If water has entered the remote control, wipe the remote control with a dry cloth immediately.
- Do not place the remote control near heat and steam sources.
- Do not attempt to disassemble the remote control, unless you need to place batteries in the remote control.

2.2.3. Operating range of the remote control

Point the top front of the remote control at the remote sensor on the display when you press the buttons.

Use the remote control within a distance of less than 5m/16ft from the display's sensor, and a horizontal and vertical angle of less than 30°.

NOTE: The remote control may not function properly when the remote control sensor on the display is under direct sunlight or strong illumination, or when there is an object between the remote control and the remote sensor of the display.

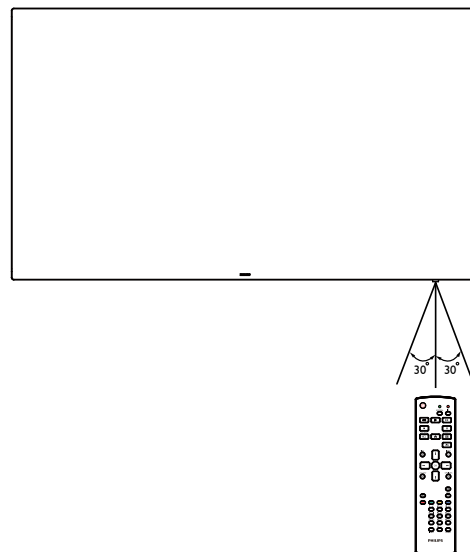

2.2.4. Using the remote sensor and power indicator

1. Push down the lens to have better remote control performance and make it easy to observe the power status.
2. Pull/push the lens until a click sound is heard.

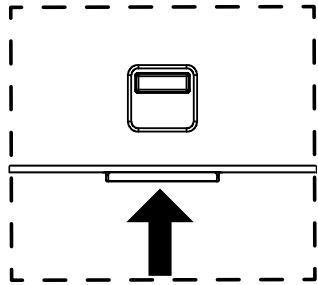

Push up to collapse the lens

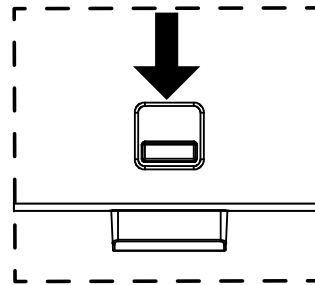

Push down to expand the lens

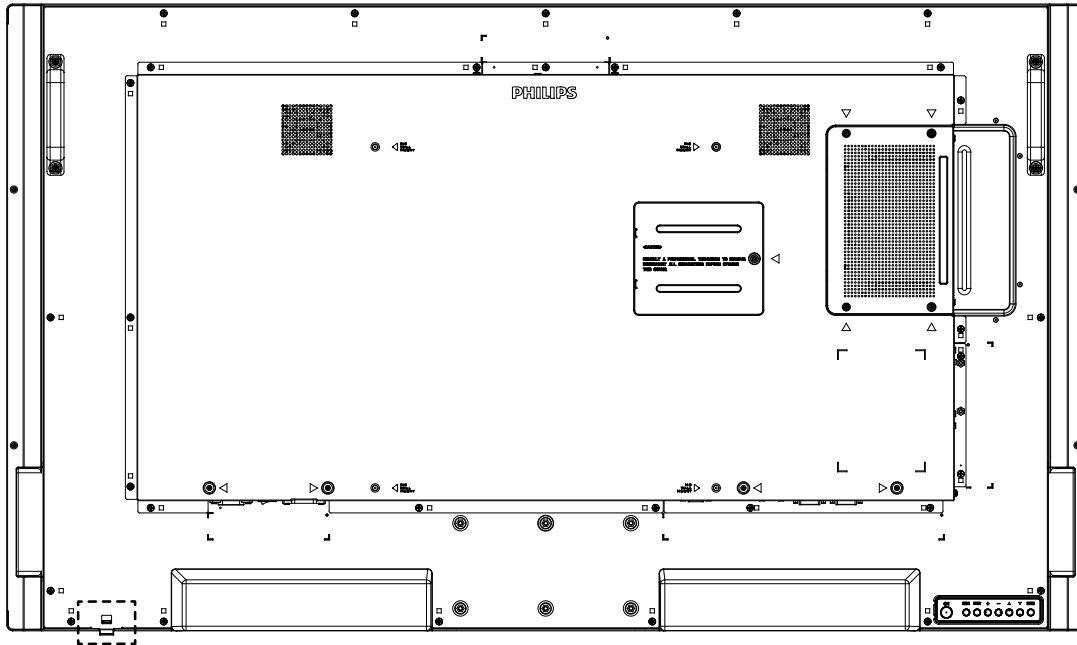

2.3. Remote Control

2.3.1. General functions

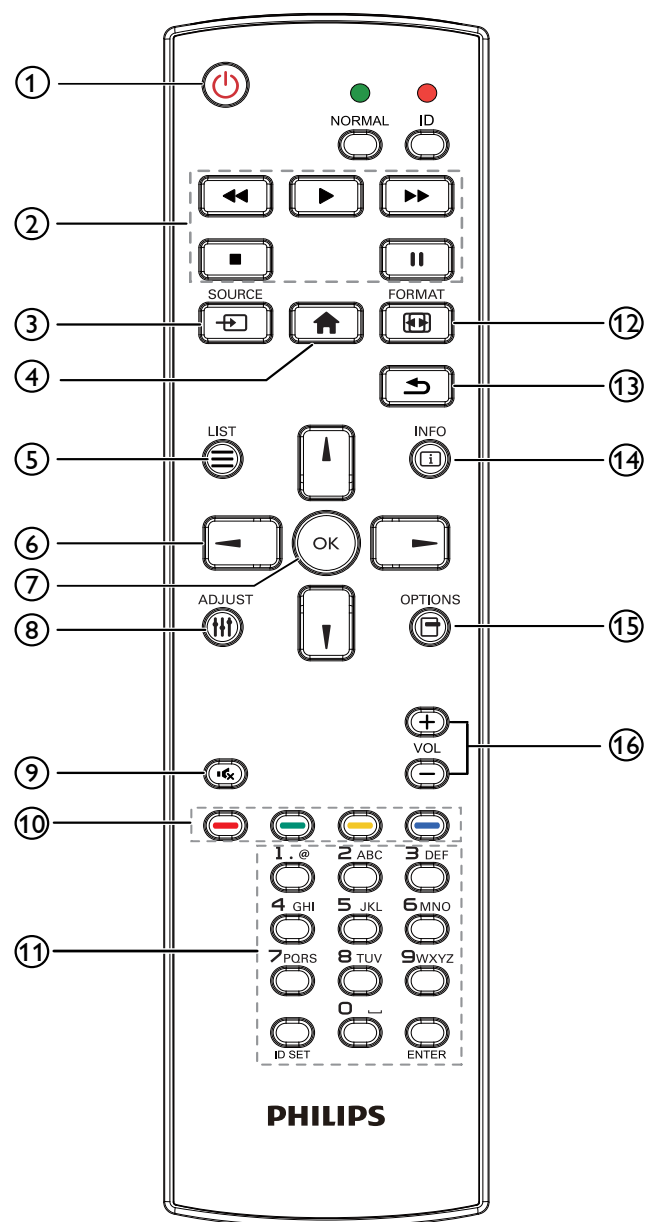

① **[POWER] button**

Turn the power On/Off.

② **[PLAY] buttons**

Control playback of media files.(for Media Input only)
Freeze feature

Pause: hotkey for freezing all inputs content.

Play: hotkey for unfreezing all input content.

③ **[SOURCE] button**

Root Menu: Go to the OSD of Video source.

④ **[HOME] button**

Root Menu: Go to the OSD of Main Menu.

Others: Exit from the OSD.

⑤ **[LIST] button**

Reserved.

⑥ **NAVIGATION buttons**



Root Menu: Go to the OSD of Smart picture.

Main Menu: Move the selected item up to make adjustment.

IR Daisy Chain Menu: Increase the controlled Group ID number.



Root Menu: Go to the OSD of Audio source.

Main Menu: Move the selected item bar down to make adjustment.

IR Daisy Chain Menu: Decrease the controlled Group ID number.



Main Menu: Go to the previous level of menu.

Source Menu: Exit from the source menu.

Volume Menu: Decrease the volume.



Main Menu: Go to the next level of menu or set selected option.

Source Menu: Go to the selected source.

Volume Menu: Increase the volume.

⑦ **[OK] button**

Root Menu: Go to the OSD of IR daisy chain in Primary/ Secondary mode.

Main Menu: Confirm an entry or selection.

⑧ **[ADJUST] button**

Go to the OSD of Auto Adjust (for VGA only).

⑨ **[MUTE] button**

Mute or unmute the sound.

⑩ **[COLOR] buttons**

Choose a task or option. (for Media Input only)

[GREEN] Hotkey for Window selection function.

⑪ **[Number/ ID SET/ ENTER] button**

Enter text for network setting.

Press to set the display ID. Refer to 2.3.2. ID Remote Control for more details.

⑫ **[FORMAT] button**

Select image zoom mode from Full, 4:3, 1:1, 16:9, 21:9 or Custom.

⑬ **[BACK] button**

Return to the previous page or exit from the previous function.

⑭ **[INFO] button**

Show Information OSD.

⑮ **[OPTIONS] button**

Reserved.

⑯ **[VOLUME] button**

Adjust the volume.

2.3.2. ID Remote Control

Set remote control ID number when using several displays.

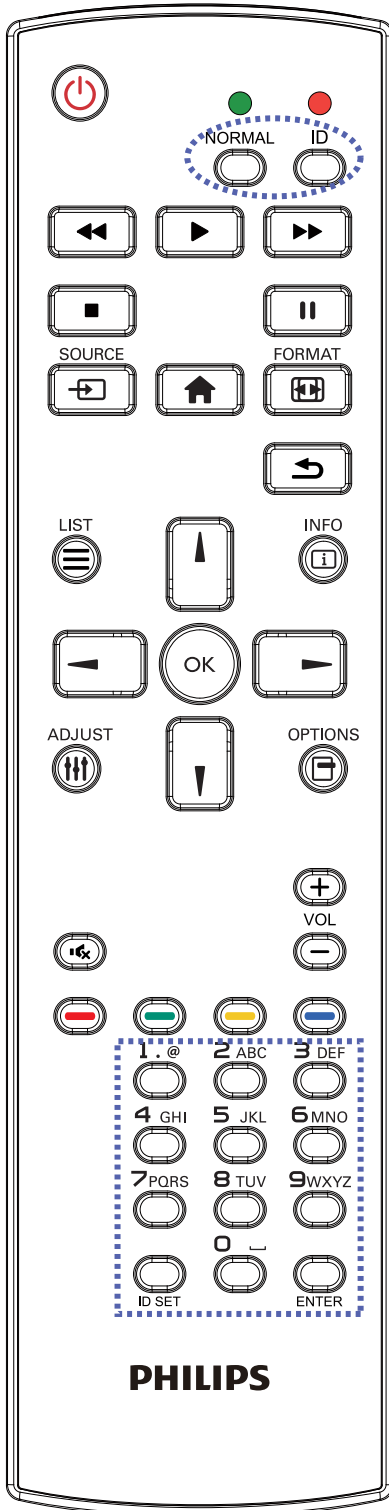

Press the [ID] button and the red LED blinks twice.

1. Press [ID SET] button for more than 1 second to enter the ID Mode. The red LED lights up.
Press the [ID SET] button again will exit the ID Mode. The red LED lights off.

Press the digit numbers [0] ~ [9] to select the display to be controlled.

For example: press [0] and [1] for display No.1, press [1] and [1] for display No.11.

The numbers available are [01] ~ [255].

2. If no button is pressed within 10 seconds, it will exit from the ID mode.
3. If a wrong button is pressed, wait for 1 second until the red LED lights off and then turns on again, then press the correct digits.
4. Press [ENTER] button to confirm your selection. The red LED blinks twice and then lights off.

NOTE:

- Press [NORMAL] button. The green LED blinks twice, indicating that the display is under normal operation.
- It is necessary to set up the ID number for each display before selecting its ID number.

2.3.3. Remote Control buttons on Android source

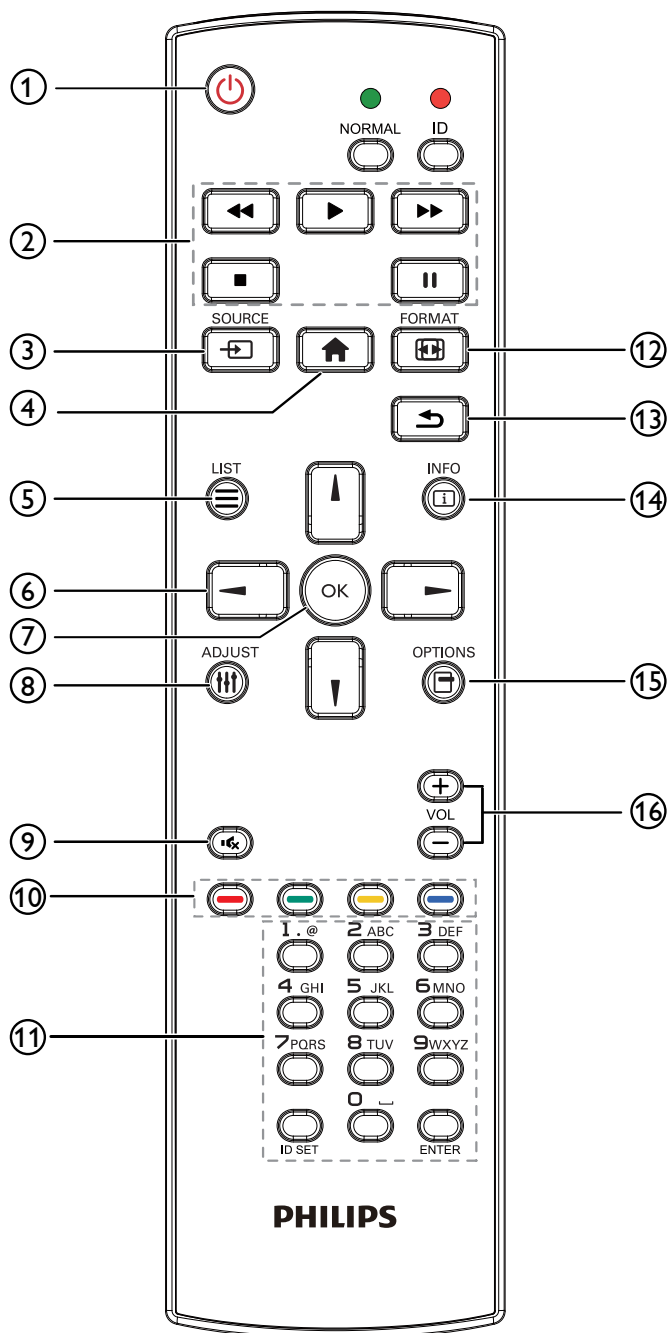

① [POWER] POWER button

Turn the display On or standby mode.
The button is only controlled by Scalar.

② [PLAY] buttons

1. Control playback of media (video/audio/picture) files.
There are 4 ways to play the media files.

1) File Manager

Find the media file from the File Manager and select it to play.

2) Media Player -> Compose -> edit or add a new playlist -> choose any media files -> press button to play the media file directly.

3) Media Player -> Play -> choose non-empty play list
-> press to play all media files from the playlist.

4) Set media playlist in Boot on Source or Schedule by OSD menu.

2. When playing a video or music file, you can press button to stop playing. If you press again, playback will be started from the beginning of the file.

3. When playing a video or music file, you can press button to pause playing.

4. All media files should be located in the folder of "philips", under the root directory of the specified storage (internal/USB/SD Card). All sub-folders (video/photo/music) are named by media types and shouldn't be changed.

videos: {root dir of storage}/philips/video/
photos: {root dir of storage}/philips/photo/
music: {root dir of storage}/philips/music/

Note that the root directories of three storages are

Internal storage: /sdcard

USB storage: /mnt/usb_storage

SD card : /mnt/external_sd

③ SOURCE button

Select an input source.

The button is only controlled by Scalar.

④ HOME button

Access the OSD menu.

The button is only controlled by Scalar.

⑤ LIST button

1. In the content of the web page, move the focus up to the next selectable items.

2. Move the focus up to the next control or widget such as buttons.

⑥ NAVIGATION buttons

1. Navigate through the menus and select an item.

2. In the content of the web page, these buttons are for controlling the scroll bar of the screen. Press or

for moving the vertical scroll bar up or down. Press or for moving the horizontal scroll bar left or right.

⑦ [OK] button

Confirm an entry or selection.

⑧ ADJUST button

1. In the content of the web page, move the focus down to the next selectable items.

2. Move the focus down to the next control or widget such as buttons.

⑨ MUTE button

Mute or unmute the sound.

The button is only controlled by Scalar.

⑩ [] [] [] [] COLOR buttons

Reserved.

⑪ [Number/ ID SET/ ENTER] button

ID SET  and ENTER  are reserved on Android source. These buttons are only controlled by Scalar.

⑫ [] FORMAT button

Change picture format. The button is only controlled by Scalar.

⑬ [] BACK button

Return to the previous page or exit from the previous function.

⑭ [] INFO button

1. Display information about the current input signal. It is shown by Scalar.
2. Media Player -> Compose -> edit or add a new playlist -> choose any media files -> press  to show the information of the selected media file.

⑮ [] OPTIONS button

Open the toolbox from Media Player.

1. Media Player ->Compose -> Edit or add a new playlist -> press  to open a toolbox. The toolbox will slide from the left side of the screen.

⑯ [] [] VOLUME button

Adjust volume level. The buttons are only controlled by Scalar.

2.4. USB Cover

- Plug in the USB device and insert the micro SD card.
- Use the screw provided to fix the USB cover.

Maximum suitable USB stick size: 20(W)x10(H)x80(L) mm

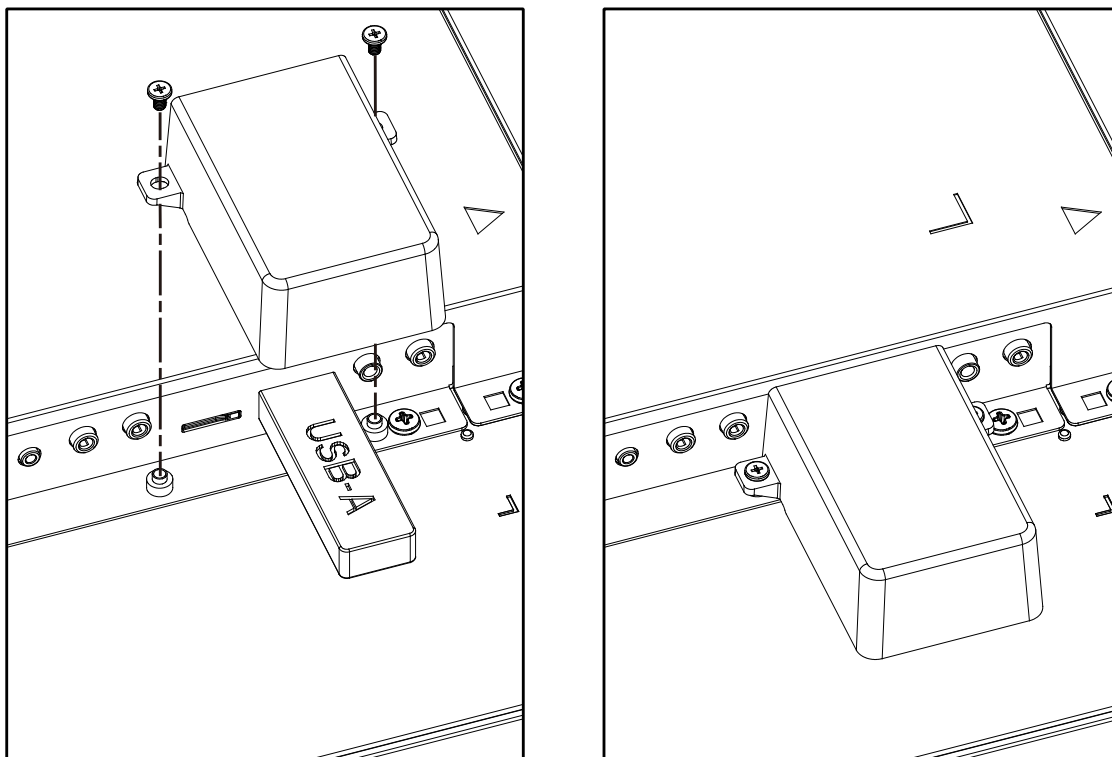
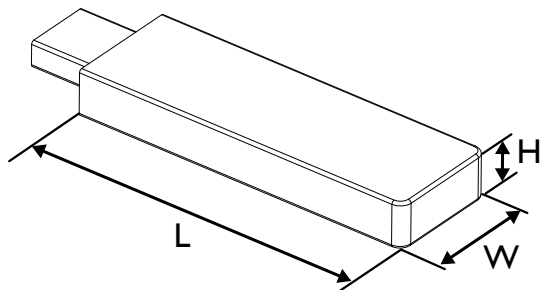

2.5. 4G Module

1. Please consult a professional technician to install the 4G module.
2. Power off the display.
3. Install the 4G module, fix it by using the M2 screws provided if necessary.
4. Connect the antenna to the 4G module.
5. Fix the service cover to the display.

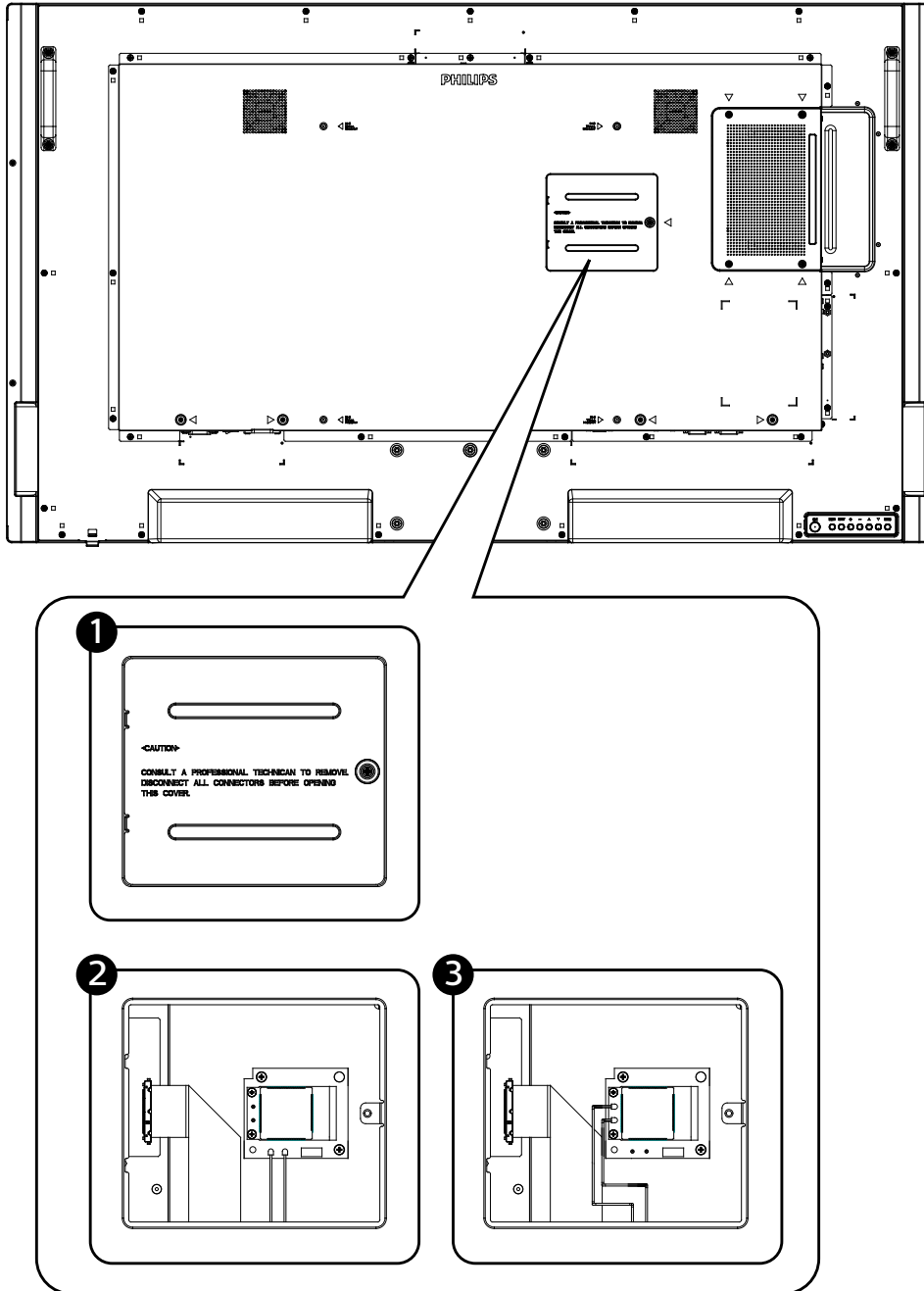

3. Connecting External Equipment

3.1. Connecting External Equipment (DVD/VCR/VCD)

3.1.1. Using HDMI video input

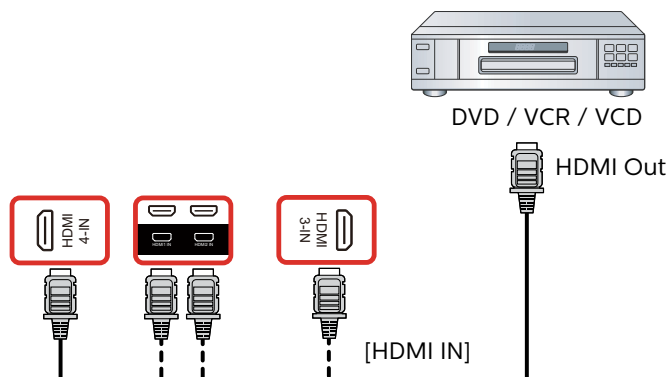

3.2. Connecting a PC

3.2.1. Using DVI input

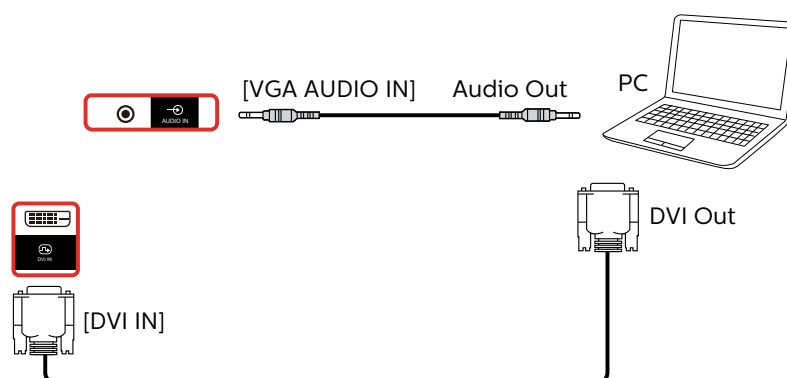

3.2.2. Using HDMI input

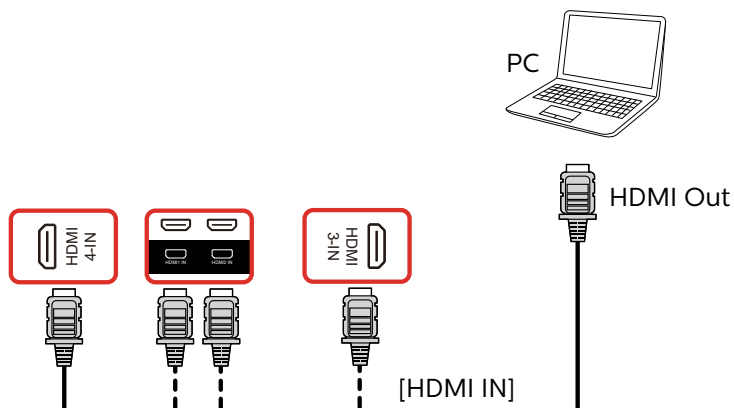

3.2.3. Using DisplayPort input

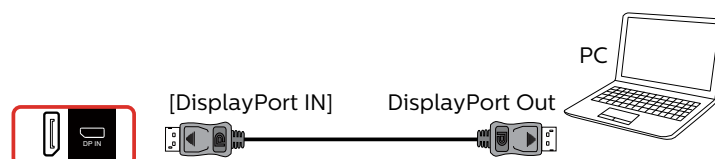

3.3. Connecting Audio Equipment

3.3.1. Connecting an external audio device

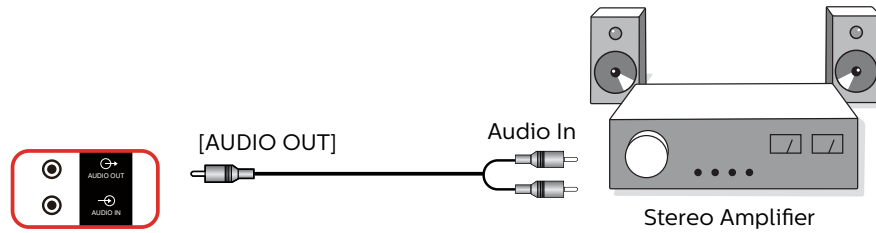

3.4. Connecting Multiple Displays in a Daisy-chain Configuration

You can interconnect multiple displays to create a daisy-chain configuration for applications such as a menu board.

3.4.1. Display control connection

Connect the [RS232 OUT] connector of DISPLAY 1 to the [RS232 IN] connector of DISPLAY 2.

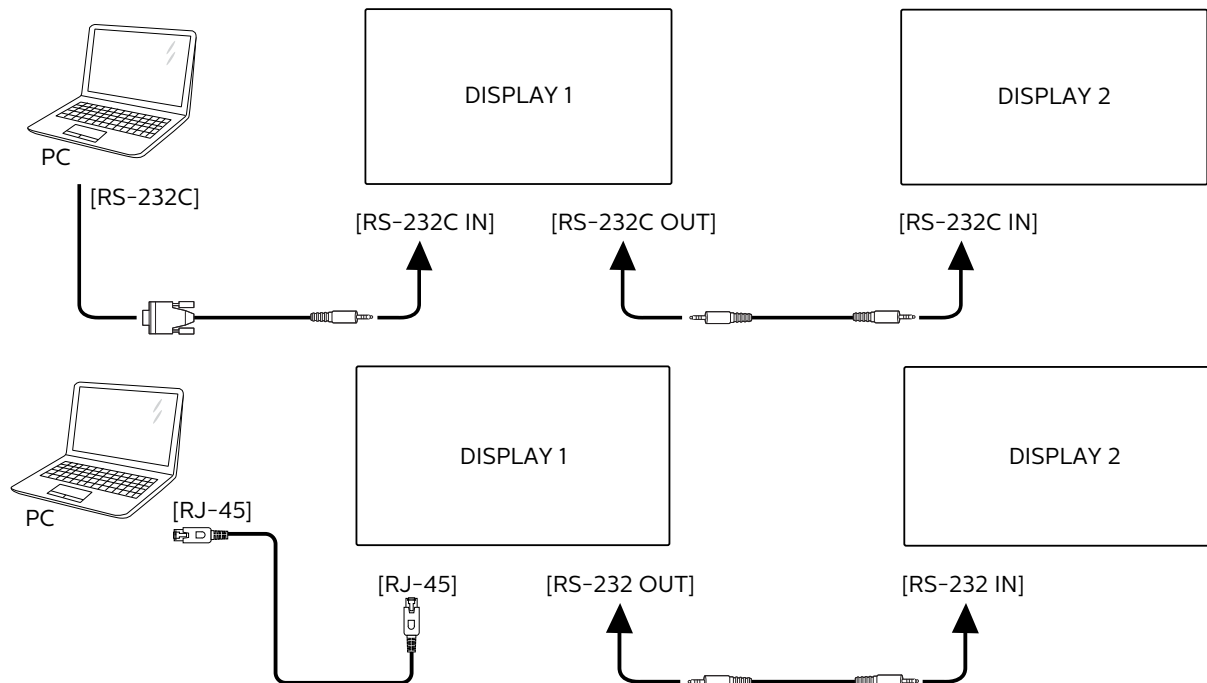

3.4.2. Digital video connection

Connect the [DP OUT] connector of DISPLAY 1 to the [DP IN] connector of DISPLAY 2.

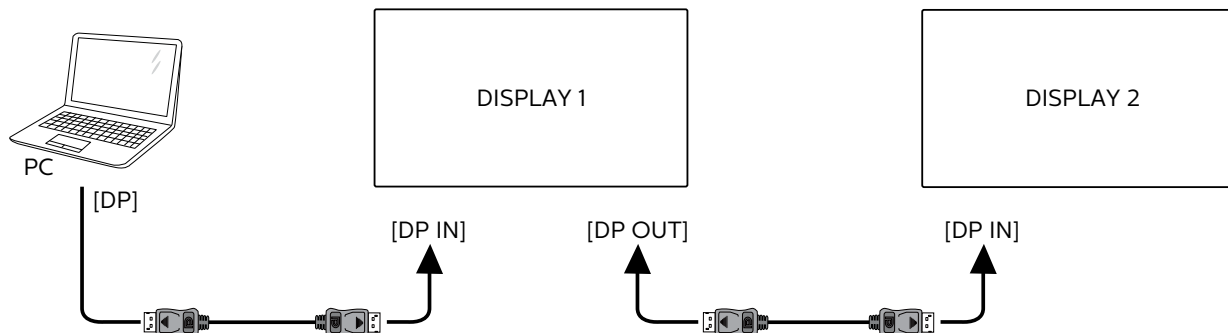

Connect the [HDMI OUT] connector of DISPLAY 1 to the [HDMI IN] connector of DISPLAY 2.

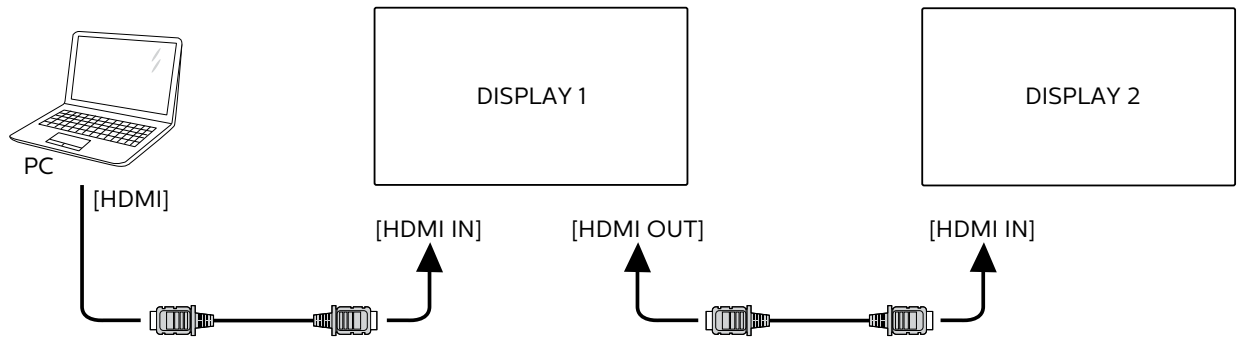

Connect the [DVI OUT] connector of DISPLAY 1 to the [DVI IN] connector of DISPLAY 2.

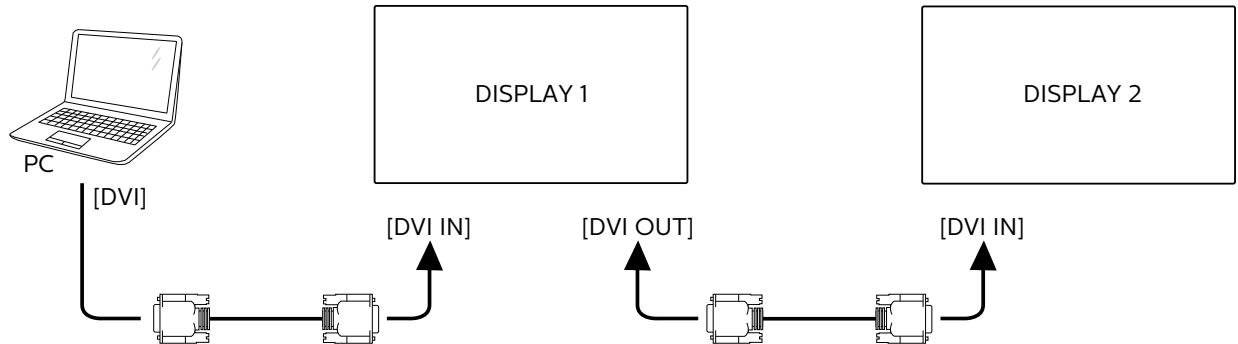

3.5. IR connection

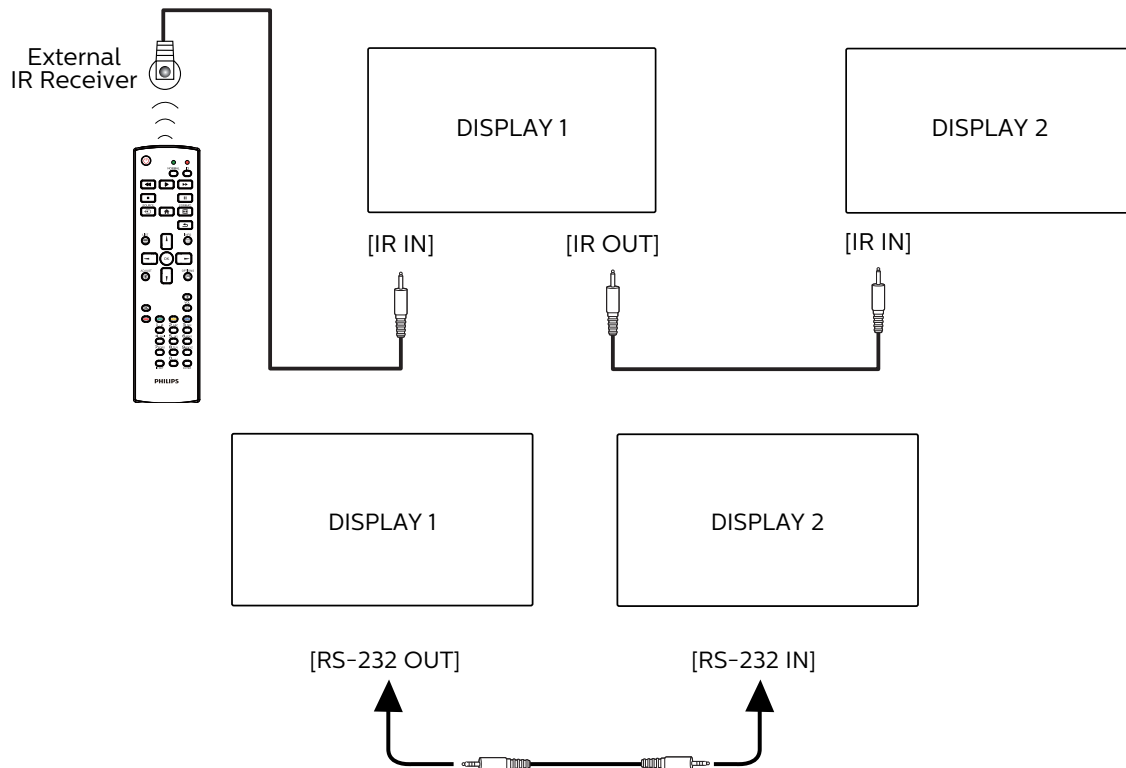

NOTE:

1. The remote control sensor of this display will stop working if the [IR IN] is connected.
2. IR loop through connection can support up to 9 displays.
3. IR in daisy chain via RS232 connection can support up to 9 displays.

3.6. IR Pass-through Connection

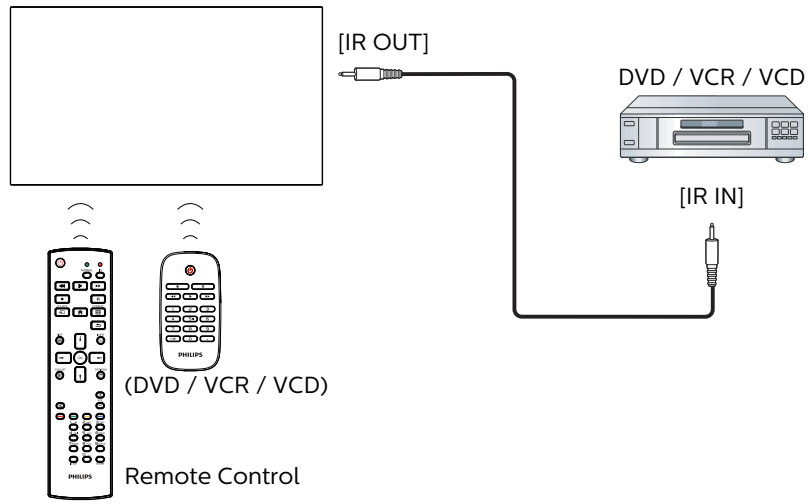

3.7. Touch Operation

This display is equipped with a touch-sensitive screen and supports the Windows Touch features either by single touch or multi-touch operation. You can touch the pictures or text on the display gently with your fingers, and the system will react.

This section explains about the touch operation on the display. For further detail on how to run the touch operation, please refer to the Windows operation instruction.

Single Tap

Touch the target on the screen with one fingertip for one quick tap, then release.

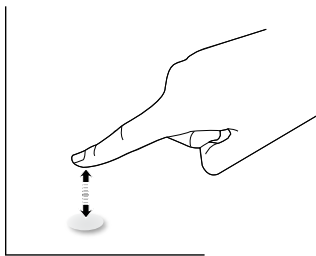

Please note that a touch screen will respond to a light touch from your fingertip when tapping on touch screen.

Double Tap

Touch the target on the screen with one fingertip for two quick taps, then release.

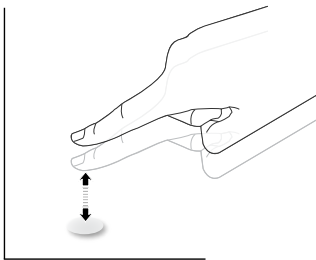

Pan

Touch the target on the screen with one fingertip and move across the target without losing direct contact, then release.

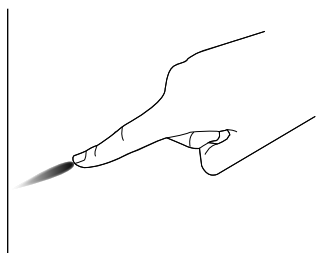

Flick

Touch the target on the screen with one fingertip and brush the surface quickly.

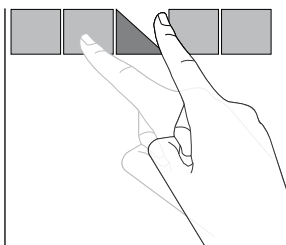

Zoom in

Touch the target on the screen with two fingertips held together and move them apart to zoom in (magnify) the screen image.

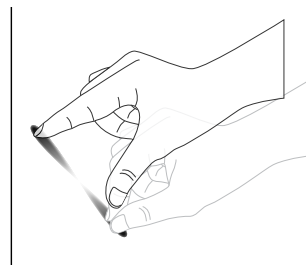

Zoom out

Touch the target on the screen with two fingertips stretched apart and move them closer to zoom out (shrink) the screen image.

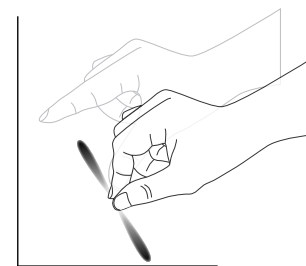

Touch and Hold

Touch and hold the target on the screen with one fingertip for a while to display a context menu or options page for an item.

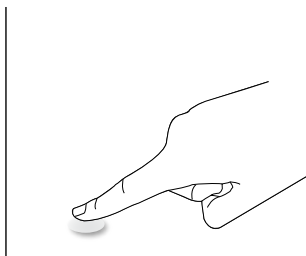

The multi Touch function is not supported by Mac OS. The OS supported is listed below.

Item	Description		
Operating Systems Supported by Plug-and-Play	Windows 7, 8/8.1, 10		
Supported Modes of Operation by the Operating System	OS	Single Touch	Multi Touch
	Windows 7, 8/8.1, 10	○	○*
	Mac OSX before (include) 10.15	○	X
	Mac OSX after (include) 10.10	○	X
	Chrome 38+	○	○**
	Android 4.0, Kernel after (include) 3.6	○	○***
	Linux	○****	○*****
	* Support multi-touch. ** Kernel 3.15 upward. *** Support 10-point touch. **** CentOS, Debian, Fedora, Gentoo, Mandrake(Mandriva), Meego, Red Hat, Slackware, SuSE(OpenSuSE), Ubuntu(Xubuntu), and Yellow Dog etc. *****Kernel 3.15 upward.		

1. We highly recommend that you use the latest Service Pack with all Windows 7 OS.
2. Digitizer input to Windows refers to touch digitizer as opposed to touch stylus in tablet PCs.
3. Set as default by Microsoft.

4. Operation

NOTE: The control button described in this section is mainly on the remote control unless specified otherwise.

4.1. Watch the Connected Video Source

1. Press the [↔] SOURCE button.
2. Press [▲] or [▼] button to select a device, then press [OK] button.

4.2. Change Picture Format

You can change the picture format to suit the video source. Each video source has its available picture formats.

The available picture formats depend on the video source:

1. Press [FORMAT] button to select a picture format.
 - PC mode: {Full} / {4:3} / {Real} / {21:9} / {Custom}.
 - Video mode: {Full} / {4:3} / {Real} / {21:9} / {Custom}.

4.3. Launcher

The Launcher consists of the following Apps:

“Conference”, “Whiteboard”, “Present” and “Apps”.

Conference: show all apps.

Whiteboard: go to whiteboard page.

Present: go to interact page.

Apps: show all apps.

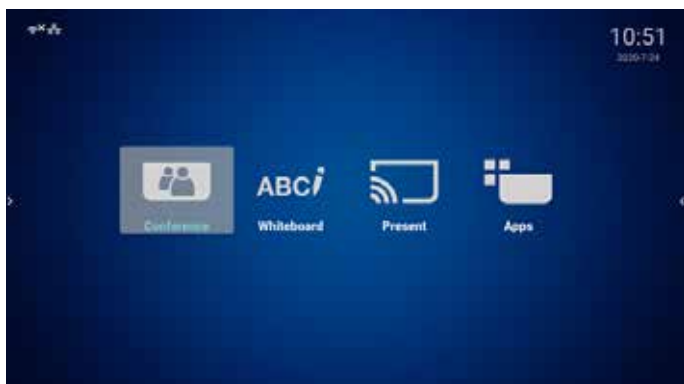

Conference page:

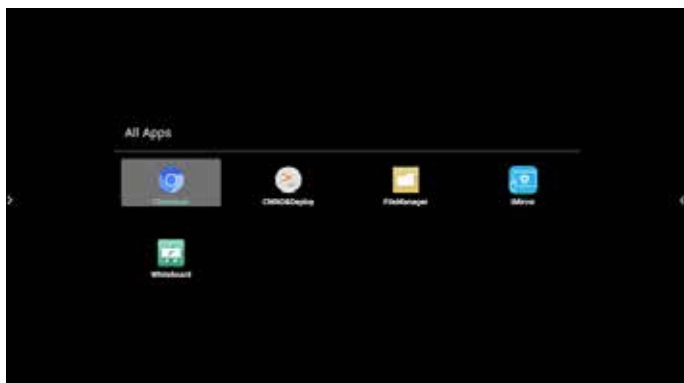

2) Whiteboard page:

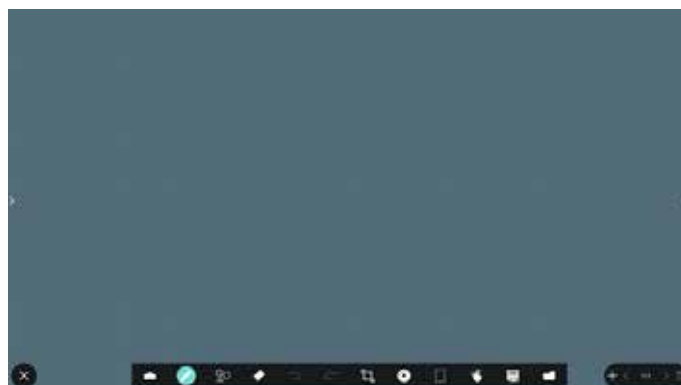

3) Present page:



4) Apps page:

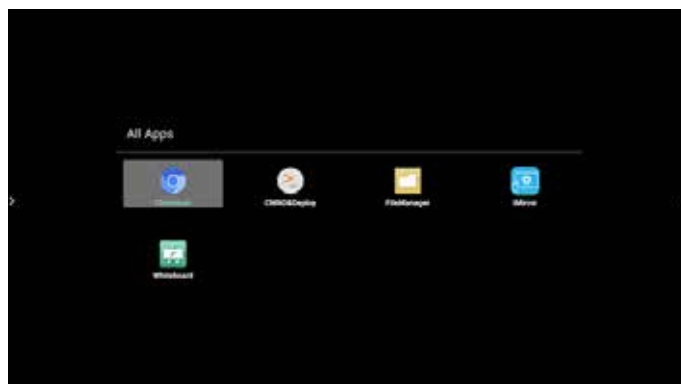

4.4. Media Player

4.4.1. OSD menu interaction with media player:

1. Boot on source:
 - Input:
 - If you select Media player as the source, the system will enter media player automatically after the boot process is completed.
 - Playlist:
 - 0: go to the main page of media player.
 - 1 - 7: go to media player and playback File1 - File7 of playlist automatically.
2. Schedule:
 - Today:
 - Show date and time.
 - 1 - 7:
 - Set up to 7 schedules.
 - On/Off:
 - Set start time and end time.
 - Input:
 - Select Media player as the source, the PD will launch the media player automatically at end time.
 - MON, TUE, WED, THU, FRI, SAT,SUN, Every week :
 - Set life cycle.
 - Play list :
 - 0: go to the main page of media player.
 - 1 - 7: go to media player and playback File1 - File7 of the playlist automatically.
 - Clear all

4.4.2. Media Player introduction:

1. Main page of Media Player app, this App consists of three items: "Play", "Compose" and "Settings".
 Play: select a playlist to play.
 Compose: edit playlist.
 Settings: set play properties.



2. Select "Play" on the main page, first you should choose one playlist to play between FILE 1 and FILE 7. The pencil icon means the playlist is non-empty.



3. Select "Compose" on the main page, first you should choose one playlist to edit between FILE 1 and FILE 7. The pencil icon means the playlist is non-empty.



4. If an empty playlist is chosen, the app will guide you through selecting the media source.

All media files should be placed in /philips/ of root directory.

For example,

- videos in /philips/video/
- photos in /philips/photo/
- music in /philips/music/



5. If you select “USB” storage, the app will guide you through selecting the USB device.

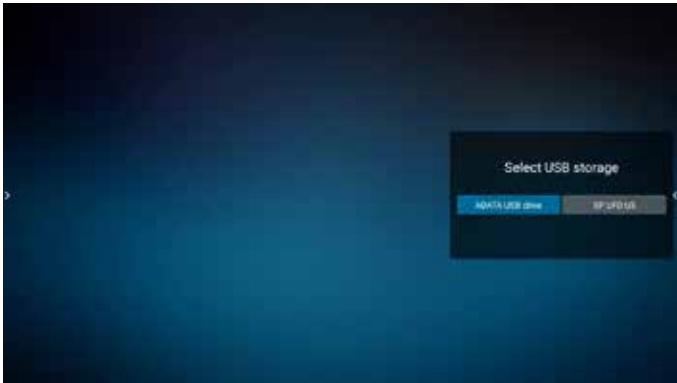

6. To edit or delete a non-empty playlist, select the desired playlist that shows a pencil icon on right side of the file.



7. Once you start to edit a playlist, a menu is displayed as below:
- Source - files in storage.
 - Playlist - files in playlist.
 - Option - launch sidebar.
 - Play - play media file.
 - Info - show media info.
 - Touch file - select/unselect file.

NOTE: When long press on one of the directory in Source, full path will be displayed.



- 7.1 In the sidebar, the following functions are available:

- Select all: select all storage files.
- Delete all: delete all playlist files.
- Add/Remove: update playlist from source.
- Sort: sort playlist.
- Save/abort: save or abort playlist.
- Back: return.

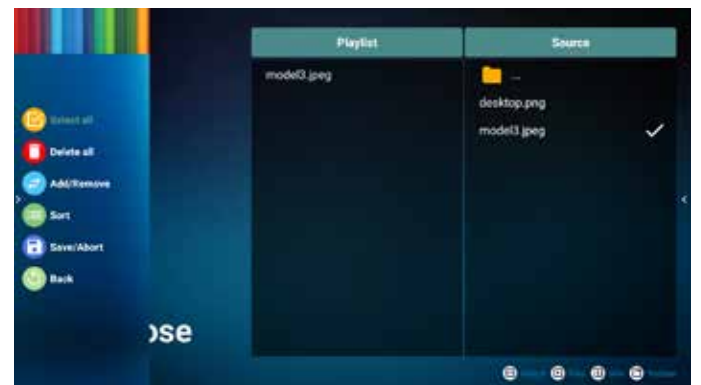

8. If “Sort” is selected, you can customize the file order severally.

NOTE: When leaving from this page, all data will be saved automatically.

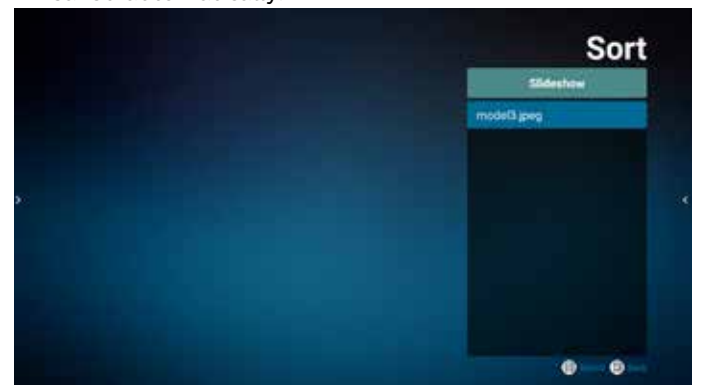

9. After selecting the desired file, press “Info” key to get detailed information.



10. After selecting the desired file, press “Play” key to play the media file immediately.



11. If you created a playlist with all image files, you will be asked to add a background music to the slideshow before saving.



12. Select “Settings” in the main page, there are five options available: “Repeat Mode”, “Slideshow Effect”, “Effect Duration”, “Software Decode” and “Autoplay”.

Repeat Mode: select repeat once or repeat all.

Slideshow Effect: photo slideshow effect (right to left, fold corner or none).

Effect Duration: photo effect duration (5 seconds, 10 seconds, 15 seconds or 20 seconds).

Software Decode: no black screen between videos play (enable, disable).

Autoplay: Plug in the USB and it will automatically play files from USB root path. (enable and disable autoplay, photo only, video only, photo and video, help).



13. Media Player import text file

Step 1. Create media player text file.

- File name : mpplaylistX.txt, "X" means playlist number(1,2,3,4,5,6,7).

Ex. mpplaylist1.txt, mpplaylist2.txt

- Content :

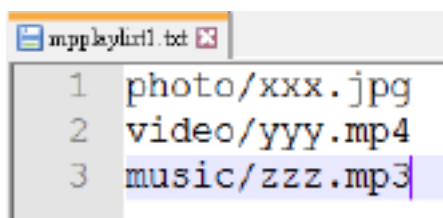

```
mpplaylist1.txt
1 photo/xxx.jpg
2 video/yyy.mp4
3 music/zzz.mp3
```

NOTE: If the playlist contains video and music files, the screen becomes black when playing music file.

Step 2. Copy "mpplaylistX.txt" to "philips" folder of internal storage. You may use FTP to do this.

- File path : /storage/emulated/legacy/philips (for DL, PL)
Ex. /storage/emulated/legacy/philips/mpplaylist1.txt

Step 3. Prepare media files to "photo", "video" and "music" folder under "philips" folder, internal storage only.

- Ex. /storage/emulated/legacy/philips/photo/xxx.jpg
/storage/emulated/legacy/philips/video/yyy.mp4
/storage/emulated/legacy/philips/photo/zzz.mp3

Step 4. Start media player app, it will automatically import media player text file.

NOTE: Once the playlist file (text) is imported, if user changes playlist via remote control, this change will not be written on playlist text file.

4.5. CMND & Play

1) Server

Setup CMND & Play server address

2) Account

Setup CMND & Play account

3) PIN Code

Setup CMND & Play PIN code

(4) Version

There are two options, Ver.2 and Ver.3

Ver. 2

use 2.0/2.2 agreement

Ver. 3

use 3.0/3.1 agreement

(5) Content

There are 3 options available: internal storage, SD card and USB storage.

If Ver.2, is selected, Server/Account/PIN code will be shown in gray and cannot be set.



4.6. Side Bar



- ① **Hide**
Hide side bar.
- ② **Home**
Open Home.
- ③ **Source menu**
Open source menu.
- ④ **IWB**
Open IWB, this item is not displayed under the IMD Home.
- ⑤ **OSD Menu**
Open OSD menu.
- ⑥ **My Favorite**
Open my favorite, add or remove frequently used APK.
- ⑦ **Quick info**
It will display the information of Time, Network and Monitor Information.
- ⑧ **History**
Show history app.
- ⑨ **Back**
Return to the previous page or exit from the previous function.

5. Setting

Main items:

- (1) Network & internet
- (2) Signage Display
- (3) App & notifications
- (4) Display
- (5) System

5.1. Network & internet

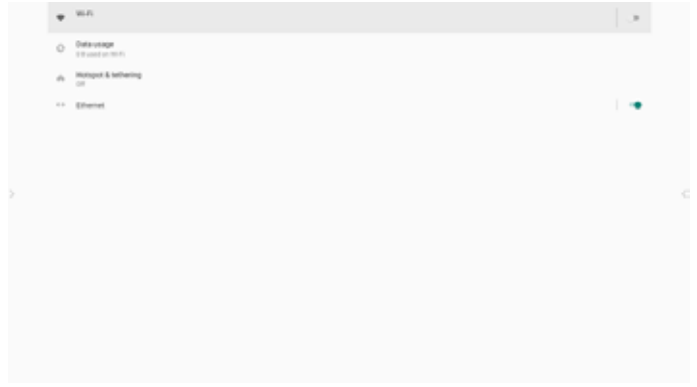

(1) Wi-Fi

There are two Wi-Fi modules in this unit, one module is used for AP function and the other one for STA function. Go to the wireless network settings. On the available network list, select an AP (Access Point) on an existing wireless network.

Notes:

1. Ethernet will be disabled automatically if Wi-Fi is connected to the network correctly.
2. A particular model of Wi-Fi module is required. Please consult the dealer or service technician for help.

(2) Data usage

Wireless and wired network usage.

(3) Hotspot & tethering

After turning it on, mobile phones, tablets, and PCs can share the platform's WiFi network by connecting to the hotspot.

You can also use the hotspot function to upload mobile, tablet, and PC screens to the platform through the **interact** software.

(4) Ethernet

Go to the Ethernet network settings and make the required settings.

After enabling Ethernet, the following settings will show:

- (1) Connection Type (available connection types: DHCP and Static IP).

A. DHCP

DHCP automatically provides the IP address, Netmask, DNS Address and Gateway to access the Internet so you do not have to enter them manually.

If the connection is successful, the current network configuration will be displayed.

B. Static IP

Enter the IP address, Netmask, DNS address and gateway manually.

Note:

Input limitation of IP address, netmask, DNS address and gateway address

(1)Format: number 0-9, decimal point “.”

(2) Mac Address

Note:

Ethernet will be disabled automatically if Wi-Fi is connected to the network correctly.

5.2. Signage Display

(1) General Settings

A. Signage display name

(2) Server Settings

A. Remote control

(3) Source Settings

A. Media player

B. CMND & Play

(4) System tools

A. Clear Storage

B. Import & Export

C. Clone

D. Admin Password

E. Swipe up

5.2.1. General Settings

1. Signage Display Name

Set PD name “PD_” + Ethernet Mac Address.

Note:

Input limitation:

(1) length: maximum 36 characters

(2) format: no limitation



5.2.2. Server Settings

1. Remote Control

Enable or disable the remote control.

Input the server address. If the server is not registered, you will be asked to enter the PIN code.

Bind status:

(1) If the device does not have appropriate network connection, a message “Network is disconnected” will appear.

(2) If the device is equipped with network function, but is not connected to the remote control server, a message “Server is disconnected” will appear.

(3) Show “Server is unbinded” if the remote control server replies its unbound status.

(4) Show “Server is binded” if the device is bound with Sever successfully.

(5) Show Error PIN code if the PIN code is not correct.

5.2.3. Source Settings

1. Media Player (Please refer to the instructions of 4.4. Media Player)

2. CMND & Play (Please refer to the instructions of 4.5. CMND & Play)

5.2.4. System Tools

System tools consist of 5 main functions:

(1) Clear Storage

(2) Import & Export

(3) Clone

(4) Admin Password

(5) Swipe up

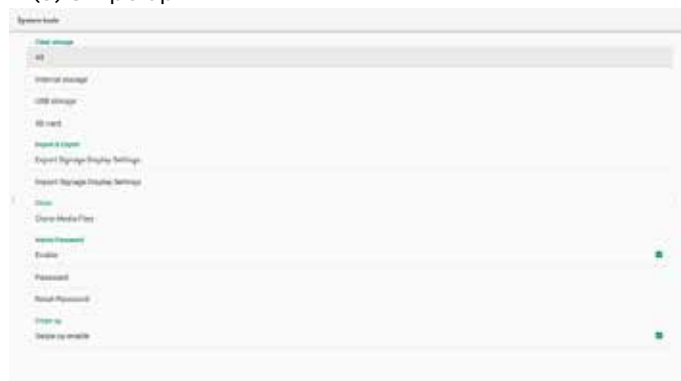

5.2.4.1 Clear Storage

The purpose is to clear data in the folder “Philips”. It is divided into 4 modes:

(1) Clear all Philips folders.

(2) Clear the folder “Philips” from the internal storage only.

(3) Clear the folder “Philips” from the USB storage only.

(4) Clear the folder “Philips” from the SD card only.

A dialog box lists all folders that the system is going to clear.

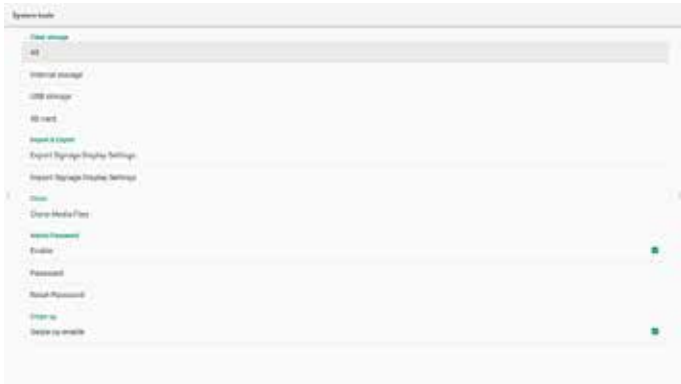

Import Signage Display Settings

Data can be imported from the folder “Philips” of the selected storage (USB storage or SD card).

- (1) Import the settings and apps
- (2) Auto install 3rd party APK from Philips/app/

A list of all available storage (internal storage/SD card/USB)



A confirmation dialog box is displayed before importing the settings and apps.



5.2.4.2 Import & Export

This function allows you to import/export the settings and 3rd party APK from/to other device.

Notes.

- (1) Saved file name:
 - A. Settings_global.xml
 - B. Settings_secure.xml
 - C. Settings_system.xml
 - D. Signage_settings.db
 - E. AndroidPDMediaPlayerData.db
 - F. AndroidPDUrlListData.db
 - G. Smartcms.db
- (2) The files will be exported to philips/sys_backup folder of the selected storage.

Export Signage Display Settings

Database will be exported to the folder “Philips” of your USB or SD card.

- (1) Export database
- (2) Export 3rd party APK to Philips/app/

Note:

If the selected storage (USB storage or SD card) does not contain the folder “Philips”, then the system will create it automatically.

A list of all available storage (internal storage/SD card/USB storage):



5.2.4.3 Clone

This function allows you to copy the media files from the folder “Philips” of your source storage (internal, SD card or USB).

1. The following folders will be copied (under the folder Philips)

- (1) philips/photo
- (2) philips/music
- (3) philips/video
- (4) philips/cms
- (5) philips/browser

2. File extension of cloned file is “.cms”)

Source storage

- (1) Internal storage
 - (a) check FTP
 - (b) check /Philips/ folder
- (2) SD/USB

Files under root

Target Location

- (1) Internal storage
 - Save to /Philips/
- (2) SD/USB
 - Save to root



5.2.3.4 Admin Password

Modify or enable/disable the admin password.

5.2.3.5 Swipe up

Enable/disable up slide to turn on source menu.

5.3. App & notifications

Display application information.

Note:

- (1) User options key on RCU to show setting option.



5.4. Display

Set the font size of display from Small/Normal/Large/Huge.

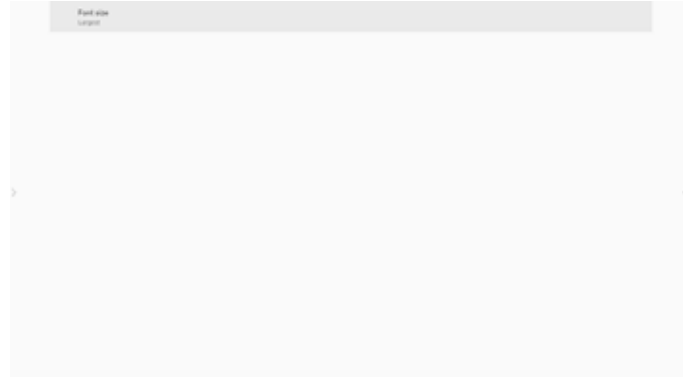

5.5. System

View the following information of the system:

- (1) About
- (2) Keyboard & inputs
- (3) Date & time
- (4) Reset options
- (5) Developer options
- (6) System updates

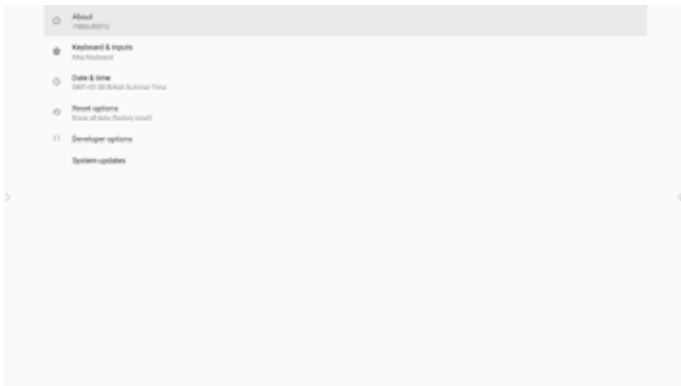

5.6. Quick Info

Press “Info + 77” to startup quick info.

Quick info will show “Network” and “Monitor Information”.

Note:

Operation hours: updates every minute.

Heat status : updates every 5 seconds.

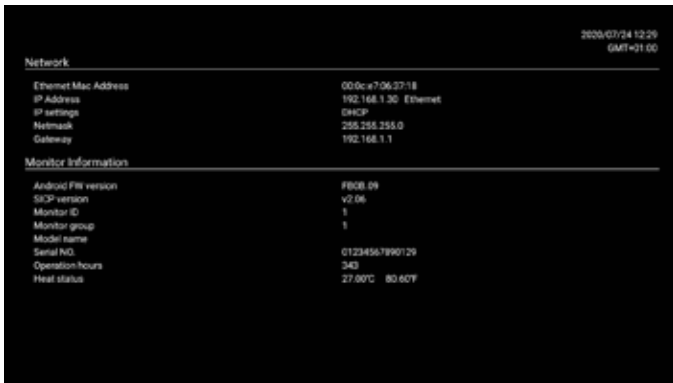

6. OSD Menu

An overview of the On-Screen Display (OSD) structure is shown below. You can use it as a reference for further adjustment of your display.

6.1. Navigating the OSD Menu

6.1.1. Navigating the OSD menu using the remote control

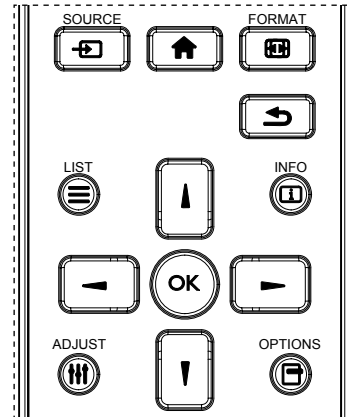

1. Press [**HOME**] button on the remote control to display the OSD menu.
2. Press [**UP**] or [**DOWN**] button to select the item to adjust.
3. Press [**OK**] or [**RIGHT**] button to enter the submenu.
4. In the submenu, press [**UP**] or [**DOWN**] button to toggle between items, press [**LEFT**] or [**RIGHT**] button to adjust the settings. If there is a submenu, press [**OK**] or [**RIGHT**] button to enter the submenu.
5. Press [**BACK**] button to return to the previous menu, or press [**HOME**] button to exit from the OSD menu.

NOTES:

- When the OSD menu is not on the screen, press [**UP**] to display the menu of **{Smart picture}**.
- When the OSD menu is not on the screen, press [**DOWN**] to display the menu of **{Audio source}**.

6.1.2. Navigating the OSD menu using the display's control buttons

1. Press [**MENU**] button to display the OSD menu.
2. Press [**+**] or [**-**] button to select the item to adjust.
3. Press [**+**] button to enter the submenu.
4. In the submenu, press [**▲**] or [**▼**] button to toggle between items, press [**+**] or [**-**] button to adjust settings. If there is a submenu, press [**+**] button to enter the submenu.
5. Press [**MENU**] button to return to the previous menu, or keep pressing [**MENU**] button to exit from the OSD menu.

6.2. OSD Menu Overview

6.2.1. Picture menu

Picture	Brightness	70
Screen	Contrast	50
Audio	Sharpness	20
Configuration	Black level	50
Advanced	Tint	50
Android Settings	Color	50
	Noise reduction	Medium
	Gamma selection	Native
	Color temperature	Native
	Color control	Action
	Overscan	Off
	Picture reset	Action

Brightness

Adjust the brightness of this display's backlight.

Contrast

Adjust the contrast ratio for the input signal.

Sharpness

Adjust the sharpness to improve the image detail.

Black level

Video black level is defined as the level of brightness at the darkest (black) part of a visual image. Adjust the black level of this display.

Tint

Adjust tint of the screen.

Press [→] button to make the tone color greenish. Press [←] button to make the tone color purplish.

NOTE: This item applies to Video mode(YUV color space) only.

Color

Adjust the intensity of colors in the image.

NOTE: This item applies to Video mode(YUV color space) only.

Noise reduction

Reduce picture noise. You can select a suitable noise reduction level.

The options are: {Off} / {Low} / {Medium} / {High}.

NOTE: This item applies to Video mode(YUV color space) only.

Gamma selection

Gamma is what controls the overall brightness of an image. Images which are not corrected properly can appear too white or too dark, so controlling the gamma properly can have a huge influence on the overall picture quality of your display.

The options are: {Native} / {2.2} / {2.4} / {S gamma} / {D-image}.

Color temperature

Select a color temperature for the image. A lower color temperature will have a reddish tint, while a higher color temperature gives off a more bluish tint.

The options are: {3000K} / {4000K} / {5000K} / {6500K} / {7500K} / {9300K} / {10000K} / {Native} / {User 1} / {User 2}.

Color control

You can adjust the color tones of the image precisely by changing the User-R (Red), User-G (Green) and User-B (Blue) settings independently.

{Picture} - {Color temperature} - {User} setting to {User 1}

Or, you can adjust the color tones per 100K in the range of 2000K to 10000K.

{Picture} - {Color temperature} - {User} setting to {User 2}

Over scan

Change the display area of the image.

- {On} - Display about 95% of the original size of the image. The rest of the areas surrounding the image will be cut off.
- {Off} - Display the image in its original size.

Picture reset

Reset all settings in the Picture menu.

6.2.2. Screen menu

Picture	H position	
Screen	V position	
Audio	Clock	
Configuration	Clock phase	
Advanced	Zoom mode	Full
Android Settings	Custom zoom	Action
	Auto adjust	Action
	Screen reset	Action

H position

Press the [→] button to move the image to the right, or [←] to move the image to the left.

NOTES:

- H position adjustment applies to VGA input only.
- H position cannot be adjusted when {Pixel Shift} is activated.

V position

Press the [↑] button to move the image up, or [↓] to move the image down.

NOTES:

- V position adjustment applies to VGA input only.
- V position cannot be adjusted when {Pixel Shift} is activated.

Clock

Adjust the width of the image.

NOTE: This item applies to VGA input only.

Clock phase



Adjust to improve the focus, clarity and stability of the image.

NOTE: This item applies to VGA input only.

Zoom mode

The pictures you receive may be transmitted in 16:9 format (wide screen) or 4:3 format (conventional screen). The 16:9 pictures sometimes have a black band at the top and bottom of the screen (letterbox format). Zoom Mode will be deactivated when **{Pixel Shift}** is activated or turned on, and when **{Tiling}** is enabled.

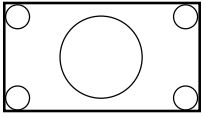
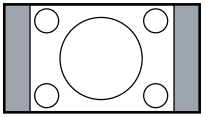
Choose from: **{Full}** / **{Normal}** / **{Real}** / **{21:9}** / **{Custom}**.

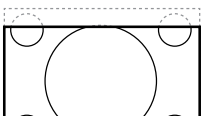
	<p>Full This mode restores the correct proportions of pictures transmitted in 16:9 using the full screen display.</p>
	<p>Normal The picture is reproduced in 4:3 format and a black band is displayed on either side of the picture.</p>
	<p>Real This mode displays the image pixel-by-pixel on screen without scaling the original image size.</p>
	<p>21:9 The picture is enlarged to 21:9 format. This mode is recommended when displaying pictures that have black bands at the top and bottom (letterbox format).</p>
	<p>Custom Apply the custom zoom settings in the Custom Zoom submenu.</p>

Custom zoom

Use this function to further customize the zoom to suit the image you want to display.

NOTE: This item works only when the {Zoom mode} is set to {Custom}.

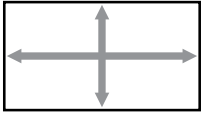
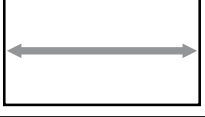
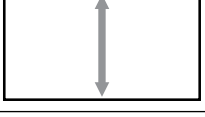
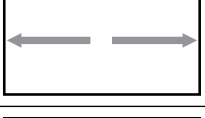
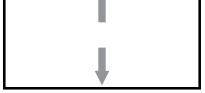
	<p>Zoom Expands the horizontal and vertical sizes of image simultaneously.</p>
	<p>H zoom Expands the horizontal size of image only.</p>
	<p>V zoom Expands the vertical size of image only.</p>
	<p>H position Moves the horizontal position of image left or right.</p>
	<p>V position Moves the vertical position of image up or down.</p>

Auto Adjust

Press "Set" to detect and adjust H position, V position, Clock, Phase automatically.

NOTE: This item applies to VGA input only.

Screen reset

Reset all settings in the Screen menu to factory preset values.

6.2.3. Audio menu

Picture	Balance	50
Screen	Treble	50
Audio	Bass	50
Configuration	Volume	20
Advanced	Audio out (line out)	20
Android Settings	Maximum volume	100
	Minimum volume	0
	Mute	Off
	Audio source	Digital
	Audio reset	Action
	Audio out sync	Off
	Speaker setting	On

Balance

Adjust to emphasize left or right audio output balance.

Treble

Adjust to increase or decrease higher-pitched sounds.

Bass

Adjust to increase or decrease lower-pitched sounds.

Volume

Adjust the volume.

Audio out (Line out)

Adjust to increase or decrease line out output level.

Maximum volume

Adjust your own limitation for the maximum volume setting. This stops the volume at the sound level you set.

Minimum volume

Adjust your own limitation for the minimum volume setting.

Mute

Turn the mute function on/off.

Audio source

Select the audio input source. Audio output is not supported when there is no video signal.

- **{Analog}** – Audio from audio input. (Audio from OPS audio input when OPS is selected as source)
- **{Digital}** – Audio from video input source. (VGA and DVI are not supported)

Audio reset

Reset all settings in the Audio menu to factory preset values for current source.

Audio Out Sync

Line out volume sync with Volume.

- **{On}** – Enable the function.
- **{Off}** – Disable the function and Audio Out Volume will be grayed out.

Speaker Setting

Enable/disable speaker.

NOTE: This function is available only when “Audio Out Sync” is on.

6.2.4. Configuration menu

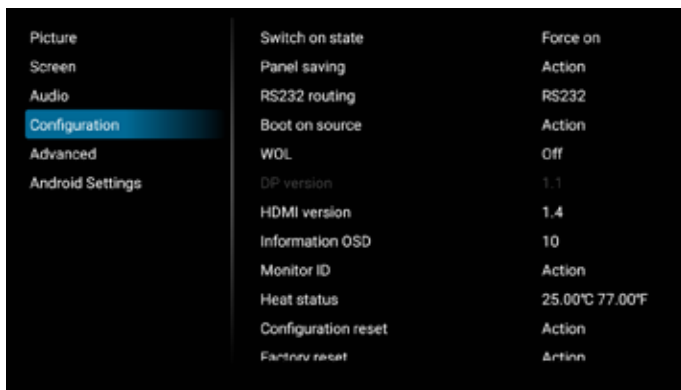

Switch on state

Select the display status that will be applied when you connect the power cord next time.

- **{Power off}** – The display will remain off when the power cord is connected to a wall outlet.
- **{Forced on}** – The display will turn on when the power cord is connected to a wall outlet.
- **{Last status}** – The display will return to the previous power status (on/off mode/standby mode) when removing and replacing the power cord.

Panel saving

Choose to enable the panel saving functions and thus reduce the risk of image persistence or ghost imaging.

- **{Brightness}** – Select {On} and the image brightness will be reduced to 30%.
- **{Pixel shift}** – Select the time interval (**{Auto}** / **{10 ~ 900}** seconds) for the display to slightly expand the image size and shift the position of pixels in four directions (up, down, left, or right). Activating Pixel Shift will disable H Position, V Position and Zoom Mode in the screen menu.

NOTES:

- Auto is 60 seconds.
- Only supports external input source (HDMI, VGA, DP, OPS, DVI)

RS232 routing

Select the network control port.

Choose from: **{RS232}** / **{LAN->RS232}** / **{OPS RS232 (OPS model only)}** / **{STANDALONE}**.

Boot on source

Choose to select source when booting up.

Last Input : keep last input when booting up.

Input: select input source(follow S12 Input source) when booting up.

Playlist: select playlist index for Media player, Browser.

0: No playlist. Same as switching source from OSD.

1-7: playlist number.

8: MediaPlayer autoplay.

No failover function, system will keep source even the source has no signal input.

WOL

Choose to turn on or off the wake on LAN function.

Choose from : **{Off}** / **{On}**.

DP Version

Change DP version. 1.1 or 1.2.

HDMI Version

Change HDMI version. 1.4 or 2.0.

Information OSD

Set the period of time the information OSD display on the screen. The options are {Off, 1-60} seconds.

Monitor ID

Set the ID number for controlling the display via the RS232C connection.

Each display must have a unique ID number when multiple sets of the display are connected. Monitor ID number range is between 1 to 255.

The option are: **{Monitor group}**.



- **{Monitor group}**

The option are: **{Off}** / **{1-254}**

- **{Off}** – **{Monitor group}** are not supported.
- **{1-254}** – **{Monitor group}** are supported. The default setting is 1.

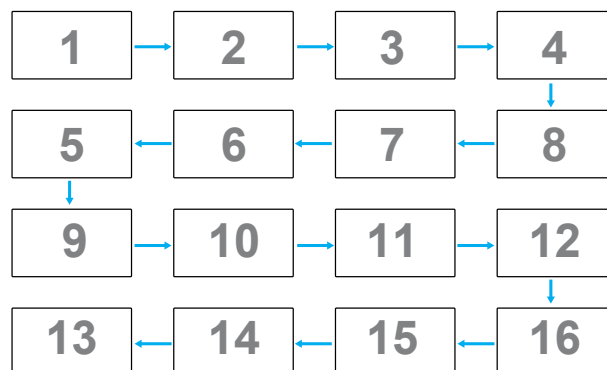

Heat status

This function allows you to check the thermal status and fan speed of the display.

	63°C	65°C	76°C	78°C
FAN	X	V	V	V
Warning MSG	X	X	V	X
PD Power Off	X	X	X	V

Configuration reset

Reset all settings in Configuration menu to the factory preset values.

Factory reset

Reset all settings in **{Picture}**, **{Screen}**, **{Audio}**, **{Configuration1}**, **{Configuration2}**, and **{Advanced option}** to the factory preset values.

Press **[←]** or **[→]** button to select **[Reset]**, and then press **[RESET]** button to do the reset.

System will be in media player mode after factory reset.



6.2.5. Advanced menu

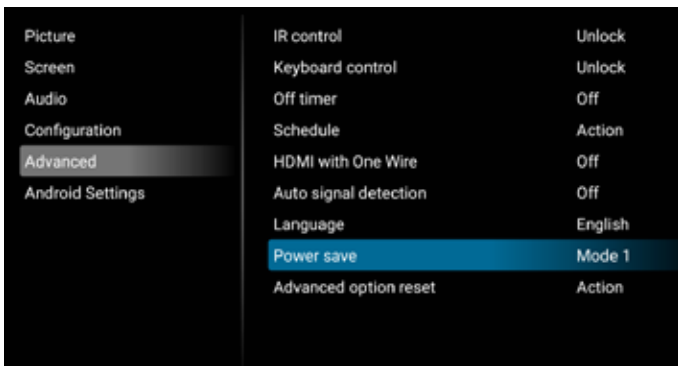

IR control

Select the operation mode of the remote control when multiple displays are connected via RS232C connection.

- **{Unlock}** - All displays can be operated normally by the remote control unit.
- **{Primary}** - Designate this display as the primary display for remote control operation. Only this display can be operated by the remote control. (In primary mode, IR key will always be processed regardless of the monitor ID/group settings.)
- **{Secondary}** - Designate this display as the secondary display. This display can not be operated by the remote control, and will only receive the control signal from the primary display via RS232C connection.
- **{Lock All}** / **{Lock all but Volume}** / **{Lock all but Power}** / **{Lock all except PWR & VOL}** - Lock the remote control function of this display. To unlock, press and hold the [Info] button on the remote control for more than 6 seconds. It will exit from OSD menu automatically after locking IR.

No warning message will be shown when IR control is locked.

Keyboard control

Choose to enable or disable the display keyboard (control buttons) function.

- **{Unlock}** - Enable the keyboard function.

- **{Lock All}** / **{Lock all but Volume}** / **{Lock all but Power}** / **{Lock all except PWR & VOL}** - Disable the keyboard function depending on the option you selected.

NOTE: “Keyboard Control Lock Mode” This function completely disables the access to all Keyboard Control functions. To enable or disable the keyboard control lock, press both [VOL+] and [UP] buttons and hold down continuously for more than 3 (three) seconds.

Off Timer

Set automatic power off time (in hours).

Schedule

1. Default start time and end time are 00:00.
2. Start time and End time must be from the same date of the schedule.

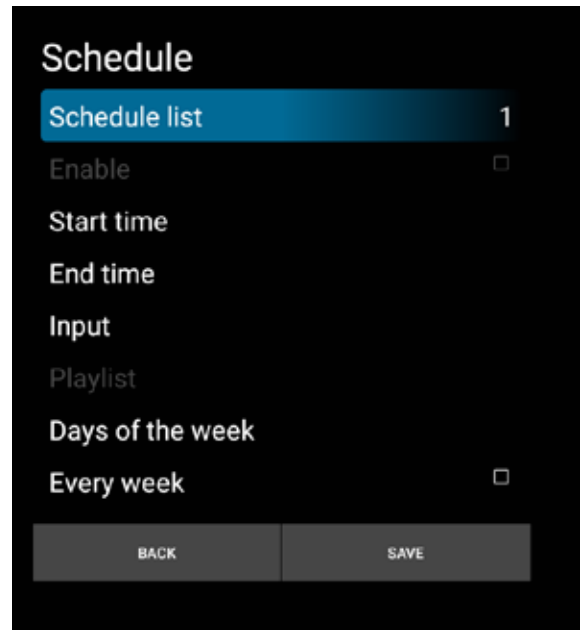

- Set lifecycle.
- Back:
 - Exit without saving changes.
- Save:
 - Save schedule data.

HDMI with One Wire

CEC control.

- **{Off}** - Disable CEC.(Default)
- **{On}** - Enable CEC.

The following features are supported:

- One Touch Play allows devices to switch the display to use it as the active source when playback starts.
- System Standby enables users to switch multiple devices to standby mode with the press of one button (HDMI with One Wire Power off is On).

Auto signal detection

This function allows the system to detect and display the available signal sources automatically.

Conditions for Auto Signal Detection:

1. Sub mode is “Off”

2. After showing Logo

3. Power state is not Power Off

The options are:

{Off}, {All}, {Failover}

{Off}: Disable Auto signal detection

{All}: OPS -> HDMI1 -> HDMI2 -> HDMI3 -> HDMI4 -> DisplayPort -> DVI-D -> USB-TypeC -> VGA -> Media Player -> SmartCMS -> Home

{Failover}:

- Failover 1: OPS(default)
- Failover 2: OPS(default)
- Failover 3: OPS(default)
- Failover 4: OPS(default)
- Failover 5: OPS(default)
- Failover 6: OPS(default)
- Failover 7: OPS(default)
- Failover 8: OPS(default)
- Failover 9: OPS(default)
- Failover 10: OPS(default)
- Failover 11: OPS(default)
- Failover 12: OPS(default)

The Failover behavior is when signal is lost, the display will go to the next available source which is defined in priority list in order.

Please note, the followings will suspend failover, and the failover will resume when signal is lost again.

- Boot On Source : When the display powers on, it will go to the source defined in this OSD option.
- Scheduler: When the display powers on by scheduler, it will go to the corresponding source according to the current time.
- User operation: No matter what current source it is, when user manually changes source, the failover will suspend.

To make sure failover starts from the 1st priority source after powering on, please set the 1st priority source as boot on source too.

Language

Select the language used in the OSD menu.

The options are: English/Deutsch/ 简体中文 /Français/ Italiano/Español/Русский/PolSKI/Türkçe/ 繁體中文 / 日本語 /Português/ العربية /Danish/Swedish/Finnish/Norwegian/ Dutch.

Power Save

Mode 1 [TCP off, WOL on, auto off]

Mode 2 [TCP off, WOL on, auto on/off]

Mode 3 [TCP on, WOL off, auto on/off]

Mode 4 [TCP on, WOL off, no auto on/off]

Power save modes

Mode 1: DC off -> Power off. LED: Red.

Power Save -> Power off, LED: Red

Mode 2: DC off -> Power off, LED: Red.

Power Save -> Power Saving. LED: Orange. Can be woken up.

Mode 3: DC off -> Back light off, LED: Red

Power Save -> Back light off, LED: Orange. Can be woken up.

Mode 4: DC off -> Back light off, LED: Red

Power Save -> Will not enter power save mode. show “no signal” only.

	RCU Power Button Off	No Signal	Android
Mode 1	DC OFF	DC OFF	board power off
Mode 2	DC OFF	when signal is back, system wake up	board power off
Mode 3	Backlight OFF	Backlight OFF	keep power on
Mode 4	Backlight OFF	Backlight ON, show no signal	keep power on

Following table is the action for Android board with different power mode.

DC off/on: press power button by RC

Power mode in OSD	Mode 1/2	Mode 3/4
DC off	shutdown	1. The current source APK(such as MediaPlayer, Browser or SmartCMS) will be closed. 2. Android system will go to the default black launcher.
DC on	Boot up	1. Android system reboots

OPS settings

Set the OPS configuration under each power condition.

- {Auto} - After selecting {Card OPS} for video source input, the OPS will be set to off when the display power is set to off, or vice versa. If you set to other video source inputs, the OPS will always be set to on.
- {Always off} - The OPS will always be set to off.
- {Always on} - The OPS will always be set to on.

Advanced option reset

Reset all settings in the Advanced option menu to factory preset values.

1. Press **[SET]** or **[←]** button to enter the submenu.
2. Press **[←]** or **[→]** button to select **{Reset}** and press the **[SET]** button to restore settings to factory preset values.

3. Press the **[EXIT]** button or select **{Cancel}** and press the **[SET]** button to cancel and then return to the previous menu.

6.2.6. Android Settings

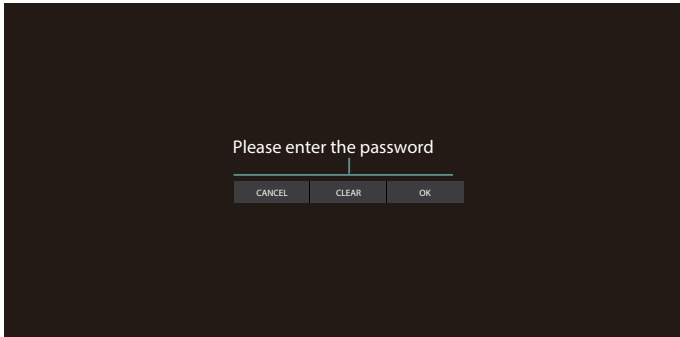

Pincode

Default password is 1234.

For more information please refer to the instructions of 5. Setting.

7. Supported Media Formats

USB Multimedia Codec Formats

Video Decode						
Type	Video Codec	Container	Decode	Encode	Channel	Remark
MPEG1/2	MPEG1/2	MPEG program stream (.DAT, .VOB, .MPG, .MPEG) MPEG transport stream (.ts) MP4 (.mp4) AVI (.avi) MKV (.mkv)	V			Max Resolution: 1080P@60fps Max Bit Rats : 40Mbps
MPEG-4	MPEG4	MP4 (.mp4) AVI (.avi) MKV (.mkv)	V			Max Resolution: 1080P@60fps Max Bit Rats : 40Mbps
H.263	H.263	FLV (.flv) AVI (.avi)	V			Max Resolution: 1080P@60fps Max Bit Rats : 40Mbps
H.264	H.264	FLV (.flv) MP4 (.mp4) MPEG transport stream (.ts) ASF (.asf) WMV (.wmv) AVI (.avi) MKV (.mkv)	V			Max Resolution: 1080P@60fps Max Bit Rats : 135Mbps 4K2K@30fps 8K@30HZ
H.265	H.265	MP4 (.mp4) MPEG transport stream (.ts) MKV (.mkv)	V			Max Resolution: 4K2K@60fps Max Bit Rats : 100Mbps 8K@30HZ
GOOGLE VP8	VP8	MKV (.mkv) WebM (.webm)	V			Max Resolution: 1080P@30fps Max Bit Rats : 20Mbps
Motion JPEG	MJPEG	AVI (.avi) MP4 (.mp4) MKV (.mkv)	V			Max Resolution: 1920*1080 @30fps Max Bit Rats : 40Mbps

Audio Decode

Type	Audio Codec	Container	Decode	Encode	Channel	Remark
MPEG Audio	MPEG1/2/2.5 Audio Layer1/2/3	MP3	V		2	Bit Rate: 8kbps~320Kbps Sampling Rate: 16KHZ~48KHz
Windows Media Audio	WMA Version 7, 8, 9,10 pro M0, 10Pro M1,M10 Pro M2	Decode: WMA	V		2	Bit Rate: 8kbps~768Kbps Sampling Rate: 8KHZ~96(M10) KHz Non-support LBR
AAC Audio	MAIN, ADIF ,ATDS Header AAC-LC and AAC-HE	File Format: AAC, M4A	V		5.1	Bit Rate: N/A Sampling Rate: 8KHZ~48KHz

Image Decode

Type	Image Codec	Photo	Decode	Encode	Channel	Remark
JPEG	JFIF file format 1.02	File Format: JPG, JPEG	V			Max Resolution: 7000 x 7000 The limitation of max resolution depends on DRAM
BMP	BMP	File Format: BMP	V			Max Resolution: 15360 x 8640 The limitation of max resolution depends on DRAM
PNG	PNG	File Format: PNG	V			Max Resolution: 15360 x 8640 The limitation of max resolution depends on DRAM

NOTES:

- Sound or video may not work if the contents have a standard bit rate/frame rate above the compatible Frame/sec listed in the table above.
- Video content with a Bit rate or Frame rate larger than the rate specified in the table above can cause choppy video during playback.

8. Input Mode

VGA/DVI timing support:

Item	Mode	Resolution	H.Freq. (KHz)	V.Freq. (Hz)
1	IBM VGA 10H	640x350	31.469	70.086
2	IBM VGA 12H	640x480	31.469	59.94
3	MACINTOSH	640x480	35	66.67
4	VESA	640x480	37.861	72.809
5	VESA	640x480	37.5	75
6	IBM VGA 3H	720x400	31.469	70.087
7	VESA	800x600	35.156	56.25
8	VESA	800x600	37.879	60.317
9	VESA	800x600	48.077	72.188
10	VESA	800x600	46.875	75.000
11	MACINTOSH	832x624	49.726	74.551
12	VESA Standard AddDMT	848x480	31	60.000
13	-	960x720	56.4	75.000
14	VESA	1024x768	48.363	60.004
15	VESA	1024x768	56.476	70.069
16		1152x864	53.986	59.985
17	VESA	1152x864	53.783	59.959
18		1152x864	63.851	70.012
19	VESA	1152x864	67.5	75.000
20	SUN WS	1152x900	61.846	66.004
21	-	1280x720	44.772	60.000
22	-	1280x720	52.5	70.000
23	CVT 2.3MA	1280 x768	47.776	59.870
24	CVT 2.3MA	1280 x768	60.289	74.893
25	CVT	1280x800	49.7	59.810
26	CVT	1280x800	62.8	74.930
27	VESA	1280x960	60	60.000
28	VESA	1280x1024	63.981	60.020
29	SUN WS	1280x1024	71.691	67.189
30	VESA	1280x1024	79.976	75.025
31	VESA Standard AddDMT	1360x768	47.712	60.015
32	VESA Standard AddDMT	1366x768	47.712	59.790
33	VESA-reduced blanking mode	1440x900	55.469	59.901
34	VESA	1440x900	55.935	59.887
35	VESA	1440x900	70.635	74.984
36	CVT-reduced blanking	1400x1050	64.744	59.948
37	CVT AddDMT	1440x1050	65.3	60.000
38	CVT	1400x1050	82.278	74.867
39	CVT Red. Blanking	1600x900	55.54	60.000
40	VESA	1600x1200	75	60
41	CVT1.76MW	1680x1050	65.29	59.954
42	CVT1.76MW-R	1680x1050	64.674	59.883
43	CVT 2.3MA-R	1920x1080	66.587	59.934
44	VESA Standard VDMTREV	1920x1080	67.5	60.000
45	CVT1960H	1920x1080	67.1584	59.963
46	VSC1960H	1920x1080	67.08	60
47	CVT 2.3MA-R	1920x1200	74.038	59.950

4K2K

Item	Resolution	H.Freq. (KHz)	V.Freq. (Hz)
1	3840x2160	53.946	23.900
2	3840x2160	54	24.000
3	3840x2160	56.25	25.000
4	3840x2160	67.432	29.900
5	3840x2160	67.5	30.000
6	3840x2160	112.5	50.000
7	3840x2160	135	60.000

Video Timing support(HDMI/DVD HD/DVI)

Item	Mode	Resolution	Comment
1	60Hz	480i	except DVI
2		480p	
3		720p	
4		1080i	
5		1080p	
6		4Kx2K	except DVI
7	50Hz	576i	except DVI
8		576p	
9		720p	
10		1080i	
11		1080p	
12		4Kx2K	except DVI

NOTE: OPS support 3840x2160@30Hz.

- The PC text quality is optimum in UHD mode (3840 x 2160, 60Hz).
- Your PC display screen might appear different depending on the manufacturer (and your particular version of Windows).
- Check your PC instruction book for information about connecting your PC to a display.
- If a vertical and horizontal frequency-select mode exists, select 60Hz (vertical) and 31.5KHz (horizontal). In some cases, abnormal signals (such as stripes) might appear on the screen when the PC power is turned off (or if the PC is disconnected). If so, press the [INPUT] button to enter the video mode. Also, make sure that the PC is connected.
- When horizontal synchronous signals seem irregular in RGB mode, check PC power saving mode or cable connections.
- The display settings table complies to the IBM/VESA standards, and based on the analog input.
- The DVI support mode is regarded as same to the PC support mode.
- The best timing for the vertical frequency to each mode is 60Hz.
- Resolution 3840x2160 50/60Hz must be equipped with HDMI certified cable(Premium High Speed HDMI Cables).

9. Pixel Defect Policy

We strive to deliver the highest quality products and use some of the industry's most advanced manufacturing processes whilst practicing stringent quality control. However, pixel or sub-pixel defects on the PDP / TFT panels used in Plasma- & LCD- displays are sometimes unavoidable. No manufacturer can guarantee that all panels will be free from pixel defects, but Philips guarantees that any Plasma- & LCD- displays with an unacceptable number of defects will be repaired during the warranty period in line with your local guarantee conditions.

This notice explains the different types of pixel defects and defines the acceptable defect level for the LCD screen. In order to qualify for repair under warranty, the number of pixel defects must exceed a certain level as shown in the reference table. If the LCD screen is within specification a warranty exchange / claim back will be refused. Additionally, because some types or combinations of pixel defects are more noticeable than others, Philips sets even higher quality standards for those.

9.1. Pixels and Sub-Pixels

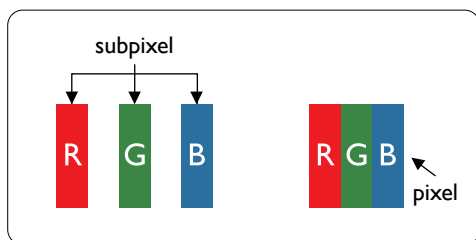

A pixel, or picture element, is composed of three sub-pixels in the primary colors of red, green and blue. Many pixels together form an image. When all sub-pixels of a pixel are lit, the three colored sub-pixels together appear as a single white pixel. When all are dark, the three colored sub-pixels together appear as a single black pixel. Other combinations of lit and dark sub-pixels appear as single pixels of other colors.

9.2. Types of Pixel Defects + Dot Definition

Pixel and sub-pixel defects appear on the screen in different ways. There are three categories of pixel defects and several types of sub-pixel defects within each category.

Dot definition = What is a defective "Dot"?

One or more defective, adjacent sub-pixel are defined as one "dot". The no. of defective sub-pixels are not relevant to define a defective dot. This means that a defective dot can consist of one, two or three defective sub-pixels which can be dark or lit.

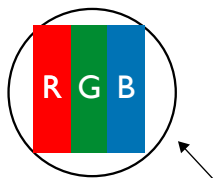

One dot = One Pixel; consists of three sub-pixels of Red, Green, and Blue.

9.3. Bright Dot Defects

Bright dot defects appear as pixels or sub-pixels that are always lit or "on". These are the examples of bright dot defects:

<p>One lit red, green or blue sub pixel</p>	<p>Two adjacent lit sub pixels: Red + Blue = Purple Red + Green = Yellow Green + Blue = Cyan (Light Blue)</p>	<p>Three adjacent lit sub pixels (one white pixel)</p>

9.4. Dark Dot Defects

Black dot defects appear as pixels or sub-pixels that are always dark or “off”. These are the examples of black dot defects:

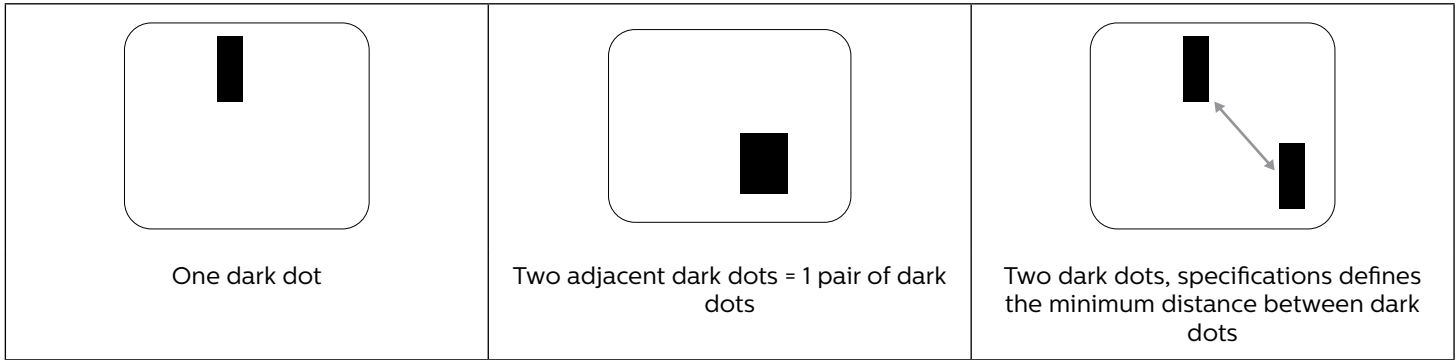

9.5. Proximity of Pixel Defects

Because pixel and sub-pixels defects of the same type that are nearby one another may be more noticeable, Philips also specifies tolerances for the proximity of pixel defects. In the table below you can find specifications about:

- Allowed amount of adjacent dark dots = (adjacent dark dots =1 pair of dark dots)
- Minimum distance between dark dots
- Total no. of all defective dots

9.6. Pixel Defect Tolerances

In order to qualify for repair due to pixel defects during the warranty period, a PDP / TFT panel in a Philips Plasma / LCD-display must have pixel or sub-pixel defects exceeding the tolerances listed in the following table.

BRIGHT DOT EFFECT	ACCEPTABLE LEVEL
1 lit sub pixel	2
BLACK DOT EFFECT	ACCEPTABLE LEVEL
1 dark sub pixel	10
TOTAL DOT DEFECTS OF ALL TYPES	12

NOTE: * 1 or 2 adjacent sub pixel defects = 1 dot defect

9.7. MURA

Dark spots or patches may occasionally appear on some liquid crystal display (LCD) panels. This is known within the industry as Mura, which is a Japanese term for “unevenness.” It is used to describe an irregular pattern or area in which uneven screen uniformity appears under certain conditions. Mura is a result of the deterioration of the liquid crystal alignment layer and is most commonly caused by long-term operation under high ambient temperatures. It is an industry- wide phenomenon and Mura is not repairable. It is also not covered by our warranty terms.

Mura has been around since the introduction of LCD technology and with screens getting bigger and in operation 24/7, many displays are running in low light conditions. This all adds to the possibility of Mura affecting displays.

HOW TO SPOT MURA

There are many symptoms of Mura and also multiple causes. Several of these are listed below:

- Impurities or foreign particles in the crystal matrix
- Uneven distribution of LCD matrix during manufacturing
- Non-uniform luminance distribution of the backlight
- Panel assembly induced stress
- Flaws within the LCD cells
- Thermal induced stress - high temperature operation over long periods of time

HOW TO AVOID MURA

Although we can not guarantee the complete eradication of Mura every time, in general the appearance of Mura can be minimized by these methods:

- Lower the backlight brightness
- Use a screen saver
- Reduce the ambient temperature around the unit

10. Cleaning and Troubleshooting

10.1. Cleaning

Caution When Using the Display

- Do not bring your hands, face or objects close to the ventilation holes of the display. The top of the display is usually very hot due to the high temperature of exhaust air being released through the ventilation holes. Burns or personal injuries may occur if any body parts are brought too close. Placing any object near the top of the display could also result in heat related damage to the object as well as the display itself.
- Be sure to disconnect all cables before moving the monitor. Moving the monitor with its cables attached may damage the cables and thus cause fire or electric shock.
- Disconnect the power plug from the wall outlet as a safety precaution before carrying out any type of cleaning or maintenance procedure.

Front Panel Cleaning Instructions

- The front of the display has been specially treated. Wipe the surface gently using only a cleaning cloth or a soft, lint-free cloth.
- If the surface becomes dirty, soak a soft, lint-free cloth in a mild detergent solution. Wring the cloth to remove excess liquid. Wipe the surface of the display to remove dirt. Then use a dry cloth of the same type to dry.
- Do not scratch or hit the surface of the panel with fingers or hard objects of any kind.
- Do not use volatile substances such as insert sprays, solvents and thinners.

Cabinet Cleaning Instructions

- If the cabinet becomes dirty, wipe the cabinet with a soft, dry cloth.
- If the cabinet is extremely dirty, soak a lint-free cloth in a mild detergent solution. Wring the cloth to remove as much moisture as possible. Wipe the cabinet. Use another dry cloth to wipe over until the surface is dry.
- Do not use solution that contains oil to clean the plastic parts. Such product damage the plastic parts and void the warranty.
- Do not allow any water or detergent to come into contact with the surface of the display. If water or moisture gets inside the unit, operating problems, electrical and shock hazards may result.
- Do not scratch or hit the cabinet with fingers or hard objects of any kind.
- Do not use volatile substances such as insert sprays, solvents and thinners on the cabinet.
- Do not place anything made from rubber or PVC near the cabinet for any extended periods of time.

10.2. Troubleshooting

Symptom	Possible Cause	Remedy
No picture is displayed	<ol style="list-style-type: none"> 1. The power cord is disconnected. 2. The main power switch on the back of the display is not switched on. 3. The selected input has no connection. 4. The display is in the standby mode. 	<ol style="list-style-type: none"> 1. Plug in the power cord. 2. Make sure that the power switch is switched on. 3. Connect a signal connection to the display.
Interference displayed on the display or an audible noise is heard	Caused by surrounding electrical appliances or fluorescent lights.	Move the display to another location to see if the interference is reduced.
Color is abnormal	The signal cable is not connected properly.	Make sure that the signal cable is attached firmly to the back of the display.
Picture is distorted with abnormal patterns	<ol style="list-style-type: none"> 1. The signal cable is not connected properly. 2. The input signal is beyond the capabilities of the display. 	<ol style="list-style-type: none"> 1. Make sure that the signal cable is attached firmly. 2. Check the video signal source to see if it is beyond the range of the display. Please verify its specifications with this display's specification section.
Display image doesn't fill up the full size of the screen	<ol style="list-style-type: none"> 1. The zoom mode is not set correctly. 2. Scan Mode may be set incorrectly to underscan. 3. If the image exceeds the screen size, Scan Mode may need to be set to Underscan. 	Use the Zoom mode or Custom zoom function in the Screen menu to fine tune display geometry and time frequency parameter.
Can hear sound, but no picture	Source signal cable is connected improperly.	Make sure that both video inputs and sound inputs are correctly connected.
Can see picture but no sound is heard	<ol style="list-style-type: none"> 1. Source signal cable is connected improperly. 2. Volume is turned all the way down. 3. {Mute} is turned on. 4. No external speaker is connected. 	<ol style="list-style-type: none"> 1. Make sure that both video inputs and sound inputs are connected correctly. 2. Press [+] or [-] button to hear sound. 3. Switch MUTE off by using the [MUTE] button. 4. Connect external speakers and adjust the volume to a suitable level.
Some picture elements do not light up	Some pixels of the display are off.	This display is designed using an extremely high level of precision technology: however, sometimes some pixels of the display may not display. This is not a malfunction..
After-Images can still be seen on the display after the display is powered off. (Examples of still pictures include logos, video games, computer images, and images displayed in 4:3 normal mode)	A still picture is displayed for an over extended period of time	Do not allow a still image to be displayed for an extended period of time as this can cause a permanent after-image to remain on the display.

<p>How to setup the settings in the menu to control all the monitors at the same time and individually via RC?</p>	<p>Daisy chained by RS232 and no IR cable</p>	<p>1. The first display sets as “Primary” on OSD (Advanced option/IR control item), others set as “Secondary”.</p> <p>2. The setup OSD will show on top left side of the display.(Toggle MENU will show again if it disappear)</p> <p>3. Default setting: ID NO: 0, GP NO: 0, this setting can control all displays by IR.</p> <p>The “+”, “-” can change “ID NO” to control signal display by “Monitor ID”.</p> <p>The “UP”, “DOWN” can change “GP NO” to control multi-display by “Group ID”.</p> <p>*The first display is always controlled by IR.</p>
<p>How is the RC working?</p>	<p>Daisy chain: no connection of RS232 and IR cable</p>	<p>No setting is required. Connect with IR cables and control by IR.</p> <p>*This may cause out-of-synchronizm phenomenon. It is suggested to use the above settings with RS-232 cable.</p>

11. Warranty Statement

Warranty period for PHILIPS signage display is listed as below, for areas not covered in this table, please follow their warranty statement.

Region	Warranty Period
USA, Canada	3 years
China	1 year
Asia Pacific	3 years
Europe	3 years
Brazil	3 years

12. Technical Specifications

Display: 55BDL6051C

Item	Specifications
Screen Size (Active Area)	138.7 cm / 54.6 inches
Aspect Ratio	16:9
Number of pixels	3840 (H) x 2160 (V)
Pixel pitch	0.315(H) x 0.315 (V) [mm]
Displayable colors	1.07G (8Bits +FRC)
Brightness (typical)	415 cd/m ²
Contrast ratio (typical)	1300:1
Viewing angle	178 degrees

In/Out Terminals:

Item	Specifications
Speaker Output	Internal Speakers 20W (L) + 20W (R) [RMS]/8Ω 82 dB/W/M/160 Hz - 13 KHz
Audio Output	3.5mm phone jack x 2 0.5V [rms] (Normal) / 2 Channel (L+R)
Audio Input	3.5mm phone jack x 1 0.5V [rms] (Normal) / 2 Channel (L+R)
RS232	2.5mm phone jack x 2 RS232 in / RS232 out
RJ-45	RJ-45 Jack x 1 (8 pin) 100 baseT
HDMI Input / output	HDMI Jack (Type A) (19 pin) in x 4 / out x 1 Digital RGB: TMDS (Video + Audio) MAX: Video - 720p, 1080p, 3840 x 2160/60 Hz Audio - 48 KHz/ 2 Channel (L+R) Supports LPCM only
Displayport in / out	Displayport Jack x 1 (20 pin) (in x1/out x1) Digital RGB: TMDS (Video + Audio) MAX: Video - 720p, 1080p, 3840 x 2160/60 Hz Audio - 48 KHz / 2 Channel (L+R) Supports LPCM only
DVI-D Output	DVI-D jack Digital RGB: TMDS (Video)
DVI-I Input	DVI-I jack Digital RGB: TMDS (Video) + Analog RGB
SD card	Micro SD card Support to 1TB
USB-B	USB-B x2 Connect touch function to external PC
USB Input	USB2.0 TypeA x2 USB3.0 TypeA x2 USB 3.0 C x1 USB2.0 USB3.0 Support input signal up to 4K/60Hz Charger 5V/3A to external device connect touch function to external PC

General:

Item	Specifications
Power Input	100 - 240V~, 50/60Hz
Power Consumption (Max)	300 W
Power Consumption (typ.)	135 W
Power Consumption (Standby mode & Off mode)	<0.5 W
Dimensions (Without Stand) [W x H x D]	1264.4 x 735.2 x 97.8 mm
Weight (Without Stand)	33.0 Kg
Gross Weight (Without Stand)	40.5 Kg
Energy Efficiency Class	B
Visible Screen Size	138.7 cm / 54.6 inches
On Mode Power Consumption (W)	128 W
Annual Energy Consumption (kWh)	187 kWh
Standby mode Power Consumption (W)	0.50 W
Off Mode Power Consumption (W)	0.30 W
Display Resolution (Pixels)	3840 x 2160
Network Standby mode (W)	2 W
EPREL registration number	xxxxxx

Environmental Condition:

Item		Specifications
Temperature	Operational	0 - 40°C
	Storage	-20 - 60°C
Humidity	Operational	20 - 80% RH (No condensation)
	Storage	5 - 95% RH (No condensation)
Altitude	Operational	0 - 3,000 m
	Storage / Shipment	0 - 9,000 m

Display: 65BDL6051C

Item	Specifications
Screen Size (Active Area)	163.9 cm / 64.5 inches
Aspect Ratio	16:9
Number of pixels	3840 (H) x 2160 (V)
Pixel pitch	0.372(H) x 0.372 (V) [mm]
Displayable colors	1.07G (8Bits +FRC)
Brightness (typical)	450 cd/m ²
Contrast ratio (typical)	1300:1
Viewing angle	178 degrees

In/Out Terminals:

Item	Specifications
Speaker Output	Internal Speakers 20W (L) + 20W (R) [RMS]/8Ω 82 dB/W/M/160 Hz - 13 KHz
Audio Output	3.5mm phone jack x 2 0.5V [rms] (Normal) / 2 Channel (L+R)
Audio Input	3.5mm phone jack x 1 0.5V [rms] (Normal) / 2 Channel (L+R)
RS232	2.5mm phone jack x 2 RS232 in / RS232 out
RJ-45	RJ-45 Jack x 1 (8 pin) 100 baseT
HDMI Input / output	HDMI Jack (Type A) (19 pin) in x 4 / out x 1 Digital RGB: TMDS (Video + Audio) MAX: Video - 720p, 1080p, 3840 x 2160/60 Hz Audio - 48 KHz / 2 Channel (L+R) Supports LPCM only
Displayport in / out	Displayport Jack x 1 (20 pin) (in x1/out x1) Digital RGB: TMDS (Video + Audio) MAX: Video - 720p, 1080p, 3840 x 2160/60 Hz Audio - 48 KHz / 2 Channel (L+R) Supports LPCM only
DVI-D Output	DVI-D jack Digital RGB: TMDS (Video)
DVI-I Input	DVI-I jack Digital RGB: TMDS (Video) + Analog RGB
SD card	Micro SD card Support to 1TB
USB-B	USB-B x2 Connect touch function to external PC
USB Input	USB2.0 TypeA x2 USB3.0 TypeA x2 USB 3.0 C x1 USB2.0 USB3.0 Support input signal up to 4K/60Hz Charger 5V/3A to external device connect touch function to external PC

General:

Item	Specifications
Power Input	100 - 240V~, 50/60Hz
Power Consumption (Max)	320 W
Power Consumption (typ.)	190 W
Power Consumption (Standby mode & Off mode)	<0.5 W
Dimensions (Without Stand) [W x H x D]	1485.1 x 860.1 x 97.4 mm
Weight (Without Stand)	45.9 Kg
Gross Weight (Without Stand)	53.9 Kg
Energy Efficiency Class	B
Visible Screen Size	163.9 cm / 64.5 inches
On Mode Power Consumption (W)	170 W
Annual Energy Consumption (kWh)	248 kWh
Standby mode Power Consumption (W)	0.50 W
Off Mode Power Consumption (W)	0.30 W
Display Resolution (Pixels)	3840 x 2160
Network Standby mode (W)	2 W
EPREL registration number	xxxxxx

Environmental Condition:

Item		Specifications
Temperature	Operational	0 - 40°C
	Storage	-20 - 60°C
Humidity	Operational	20 - 80% RH (No condensation)
	Storage	5 - 95% RH (No condensation)
Altitude	Operational	0 - 3,000 m
	Storage / Shipment	0 - 9,000 m



2021 © TOP Victory Investments Ltd. All rights reserved.

This product has been manufactured by and is sold under the responsibility of Top Victory Investments Ltd., and Top Victory Investments Ltd. is the warrantor in relation to this product. Philips and the Philips Shield Emblem are registered trademarks of Koninklijke Philips N.V. and are used under license.

Specifications are subject to change without notice.

Version: V1.00 2021-03-15