



  
**HOME OFFICE**  
By Multibrackets



**H**ow to Work Effectively From Home. The work-from-home job just got a big push globally. But even before this increasing numbers of people have been saying goodbye to their onerous commute to work. Thanks to ever-evolving technologies like Skype, Facetime, Slack, Zoom, Google Hangouts, authenticator apps and cloud computing - not to mention texting and email - it's no longer necessary to be in an office full-time to be a productive member of the team. In fact, many kinds of work can be done just as effectively, if not more so, from a home office. As appealing as remote work is to employees, it wouldn't be such a strong trend if employers didn't also recognize benefits from their side of the desk. Companies with work-from-anywhere policies can boost employee productivity, reduce turnover and lower organizational costs.

Whether you're working remotely one day per week (or more) or full-time—by choice or because of a health situation or weather event—it's important to ensure that you are set up to be productive. Multibrackets has many tools to support your everyday work-from-home.



## HOME OFFICE

M Laptop Workstation .....	6 - 9
M Deskmount Slim Basic Single .....	10 - 13
M Deskmount Slim Basic Dual .....	14 - 17
M Deskmount XL .....	18 - 21
M VESA Gas Lift Arms .....	24 - 29
M VESA Deskmount Dual Vertical Wide .....	30 - 33
Headset Stands .....	34 - 35
Cable Management .....	36 - 37





# M LAPTOP WORKSTATION SIT AND STAND WHEN WORKING FROM HOME

Own your space, move up and down while infusing your workdays with movement and ergonomics.

Introducing an easy stand desk solution for everyone at work or at home. Now you can convert any open space into a Deskstand Workstation in a matter of seconds. Lets start enable easy height adjustment and great ergonomics with effortless touch, at home. Once you started to use this you will never go back to an old desk again, trust us - this way of work will be addictive!

This height-adjustable sit and standing desk moves quietly straight up and down as you go from sit to stand. Take your worksurface, Notebook and pivot to new heights in seconds.

This ingenious product converts any open surface to a workspace. Simply hold the handle on the side of the desk and move your M Laptop Workstation to a standing or sitting position. The worksurface holds your notebook and is ultra flexible to use with your most common accessories.



## M Laptop Workstation White / Black

**Article No:** 7350073739141 - White  
7350073739127 - Black

**Height adjustment:** 60-420mm

**Table size:** 580x320 mm

**Material:** Steel, Aluminum, Plastic

**Surface Finish:** Powder Coating

**Colour:** White / Black

**Max load:** 2~10kg

**Function:** Gas driven piston

**Tilt angle:** :+0°~-30°

**Installation:** Freestanding

**Measurements:** 580x420x170mm

**Weight:** 7.2 kg

**Warranty:** 2 years

## SIT & STAND

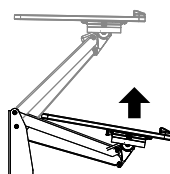

Improve your posture  
Switch between standing  
and sitting position



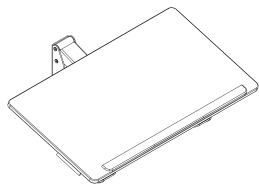

**Small & compact**  
Designed to fit small tables and work spaces

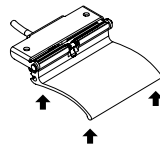

**Quick elevation**  
Adjust the release handle to elevate the table quickly

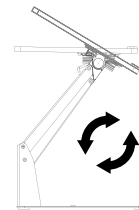

**Tiltable table**  
Easily tilt your laptop for better viewing

## HIGHLIGHTS

- Improve your productivity by switching between sitting and standing position whilst at work
- Save your back long term as you can choose to stand up or sit down
- Provides ample of smooth vertical height adjustment
- User-friendly torque adjust holds the display weight and the rest of your work area in position with ease
- Designed for ultimate productivity in areas where less surface is available

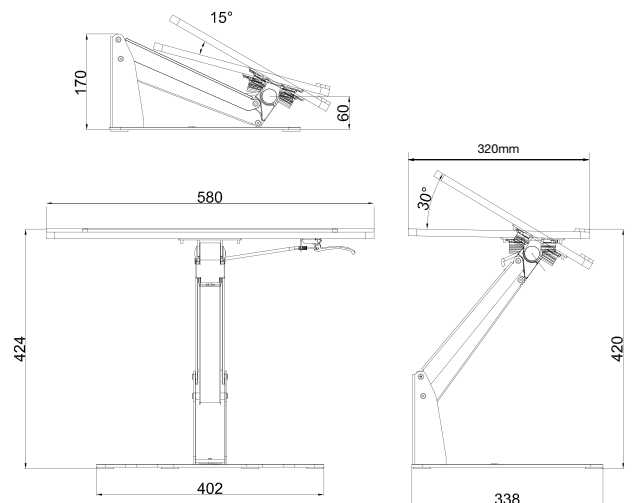





# M DESKMOUNT SLIM BASIC SINGLE A HIGH-EFFICIENCY WORKSPACE SOLUTION

Free up occupied desk space through a unique design that provides easier maneuverability and capable of moving even to fit flush against a wall.

Perfect for 17" up to some 32" monitors, this monitor arm offers height as well as screen angle adjustments for your optimal viewing and ergonomic posture. With a maximum weight capacity of 8kg, it can be easily mounted on most desktop surfaces with a clamp-on design that reduces installation time.

If your workspace isn't too big, Multibrackets new minimal monitor mount M Deskmount Slim Basic Single could help by freeing you up some space. The newly unveiled M Deskmount Slim Basic Single, a screen that clamps onto your desk and according to the company can increase your desk space by up to 40 percent. Flexible, sleek and streamlined, the M Deskmount Slim Basic Single frees up space and allows positioning of your display for greater productivity.

## SPACE SAVER

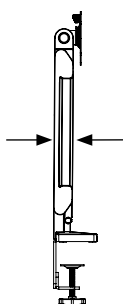

Save 40% desk space!  
Designed to fit small  
tables and work spaces



### M Deskmount Slim Basic Single

<b>For screen size:</b>	17"-32"
<b>Feature:</b>	Space saver
<b>VESA standard:</b>	75x75,100x100
<b>Article No:</b>	735007373 9974
<b>Size in mm: (H*W*D)</b>	114 x 92 x 615mm
<b>Fits Curved Screens?</b>	Yes
<b>Tilt:</b>	Yes, approx. -5 to 90 degrees
<b>Swivel:</b>	N/A
<b>Rotation of TV plate:</b>	Yes, approx. -180°~+180° degrees
<b>Cable Management:</b>	Yes
<b>Weight:</b>	3.22 kg (weight of one packed unit)
<b>Colour:</b>	Black
<b>Max load:</b>	2-8 kg
<b>Distribution package:</b>	6 pcs
<b>Warranty:</b>	5 years

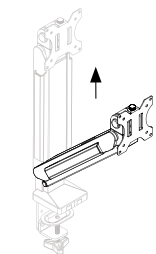

**Adjust height**  
Adjust the height of the screen

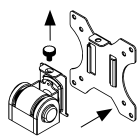

**Detachable VESA**  
Detachable VESA plate makes installation easy

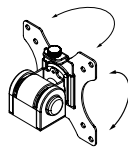

**Tilt & swivel**  
Easily adjust the screen for better view

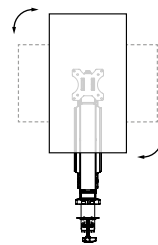

**Portrait & landscape**  
Rotate the screen for a suitable view

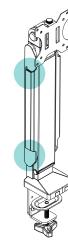

**Cable Management**  
Easily hide your cables in good order

## HIGHLIGHTS

- Space-Saving Design
- Detachable VESA plate makes installation easy
- Built in Cable management
- Adjust height for an optimal ergonomic position

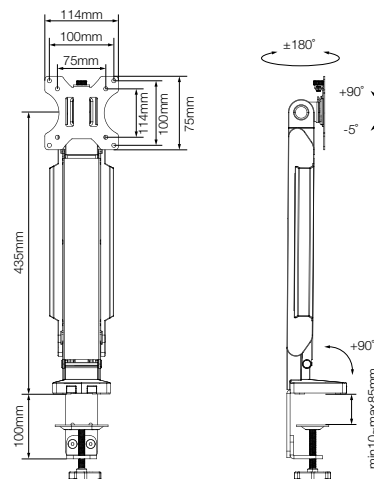





# M DESKMOUNT SLIM BASIC DUAL A HIGH-EFFICIENCY WORKSPACE SOLUTION

If your workspace isn't too big and you still want two displays, you should take a closer look at this product.

A well designed high efficiency workspace solution. This product aims at freeing up occupied desk space through a unique design that provides easier maneuverability and capable of moving even to fit flush against a wall. Perfect for displays ranging between 17" and 27" in size, this monitor arm offers height as well as screen angle adjustments for your optimal viewing and ergonomic posture. With a maximum weight capacity of 6.5kg per screen it can be easily mounted on most desktop surfaces with a clamp-on design that reduces installation time.

If your workspace isn't too big and you still want two displays, you should take a closer look at this product.



## M Deskmount Slim Basic Single

<b>For screen size:</b>	17"-32"
<b>Feature:</b>	Space saver
<b>VESA standard:</b>	75x75,100x100
<b>Article No:</b>	735007373 9981
<b>Size in mm: (H*W*D)</b>	717 x 128 x 628mm
<b>Fits Curved Screens?</b>	Yes
<b>Tilt:</b>	Yes, approx. -20° to 45° degrees
<b>Swivel:</b>	15°~ -15° degrees
<b>Rotation of TV plate:</b>	Yes, approx. -180°~+180° degrees
<b>Cable Management:</b>	Yes
<b>Weight:</b>	5.56kg ( weight of one packed unit)
<b>Colour:</b>	Black
<b>Max load (per screen):</b>	2~6.5kg
<b>Warranty:</b>	5 years

# SPACE SAVER

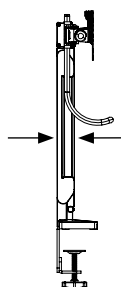

Save 40% desk space!  
Designed to fit small  
tables and work spaces



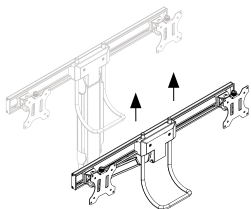

**Adjust height**  
Easily adapt the height of the screen

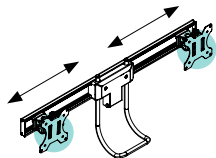

**Lateral Shift**  
Slide each monitor horizontally with ease

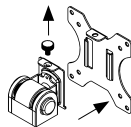

**Detachable VESA**  
Detachable VESA plate makes installation easy

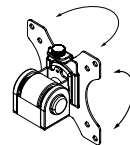

**Tilt & swivel**  
Easily tilt your screen for better viewing

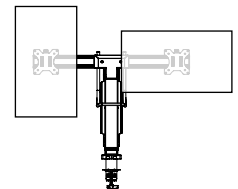

**Portrait & landscape**  
Rotate the screen for a suitable view

## HIGHLIGHTS

- Dual display space-saving design
- Built in handle for easy grip & reposition both screens at once
- Detachable VESA plates makes installation easy
- Lateral shift possible
- Built in Cable management
- Adjust height for an optimal ergonomic position

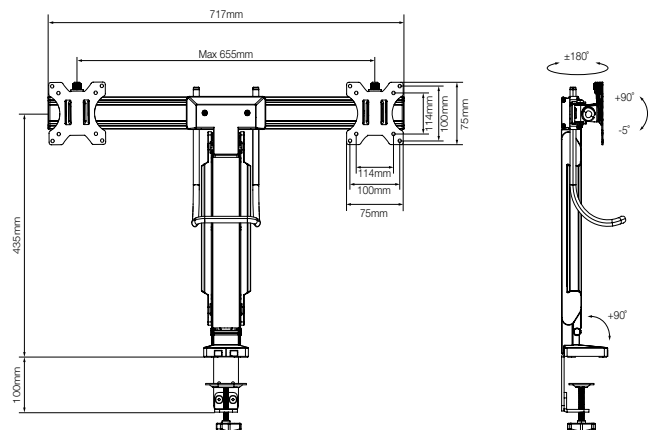





# M DESKMOUNT XL

## THE NEW BIG SIZE LIFESTYLE MONITORS WORKS AS TV AND DISPLAY IN ONE! UP TO 55"

Versatile and affordable 'do-it-all' screen offers flexibility for work, learning and entertainment at home.

This is a height adjustable tabletop mount for large size displays with an ultra slim design. With the increasing demand for large size displays and video conference equipment and more focus on collaborative working, we introduced the M Deskmount XL Black.

Easily Mount 32"-55" Monitors or TVs to a Multimedia Table for Use in Conferences, Displays or Presentations. With support of interactive displays, and other large size displays, our mounts can attach quickly to most any surface and support for video conferences or training, group discussions or presentations in offices, especially in huddle rooms. Rear back hides hardware for a clean look.



## SPACE SAVER

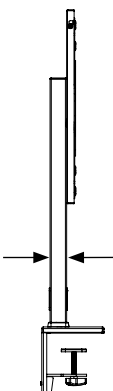

Ultra slim  
Designed to fit small  
tables and work spaces

### M Deskmount XL White / Black

<b>Article No:</b>	7350105210129 - Black 7350105210136 - White
<b>Colour:</b>	Black / White
<b>For screen size:</b>	32" - 55"
<b>VESA standard:</b>	75x75, 100x100, 200x200, 300x300, 400x400
<b>Max load:</b>	35 kg
<b>Height adjustment:</b>	Yes. 440/490/540mm
<b>Cable Management:</b>	Yes
<b>Size in mm: (H*W*D)</b>	460 x 150 x 924 mm
<b>Weight:</b>	8.1
<b>Warranty:</b>	5 years

**Dual Use  
TV & Monitor**

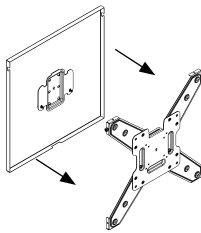

**Detachable VESA**  
Detachable VESA plate makes installation easy

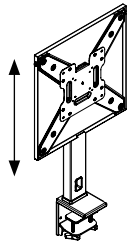

**Height adjustment**  
Height can be adjusted to three different stages

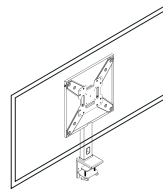

**Extra Large Screens**  
Handles large size screens & displays

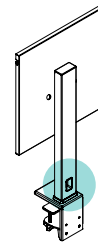

**Cable Management**  
Easily hide your cables in good order

**HIGHLIGHTS**

- Handles large size displays 32" - 55"
- Ultra slim and space saving
- Three stage height adjustment
- Built in cable management
- Detachable VESA plate
- Elegantly designed back coverplate

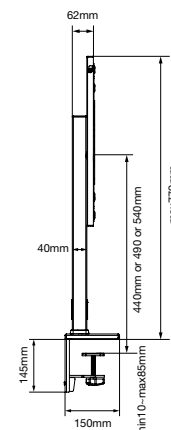
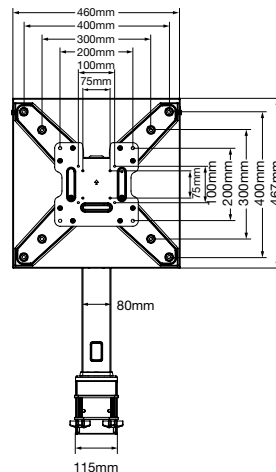



# HOME OFFICE

By Multibrackets



DESIGNED &  
ENGINEERED  
IN SWEDEN

Multibrackets supports your everyday work-from-home

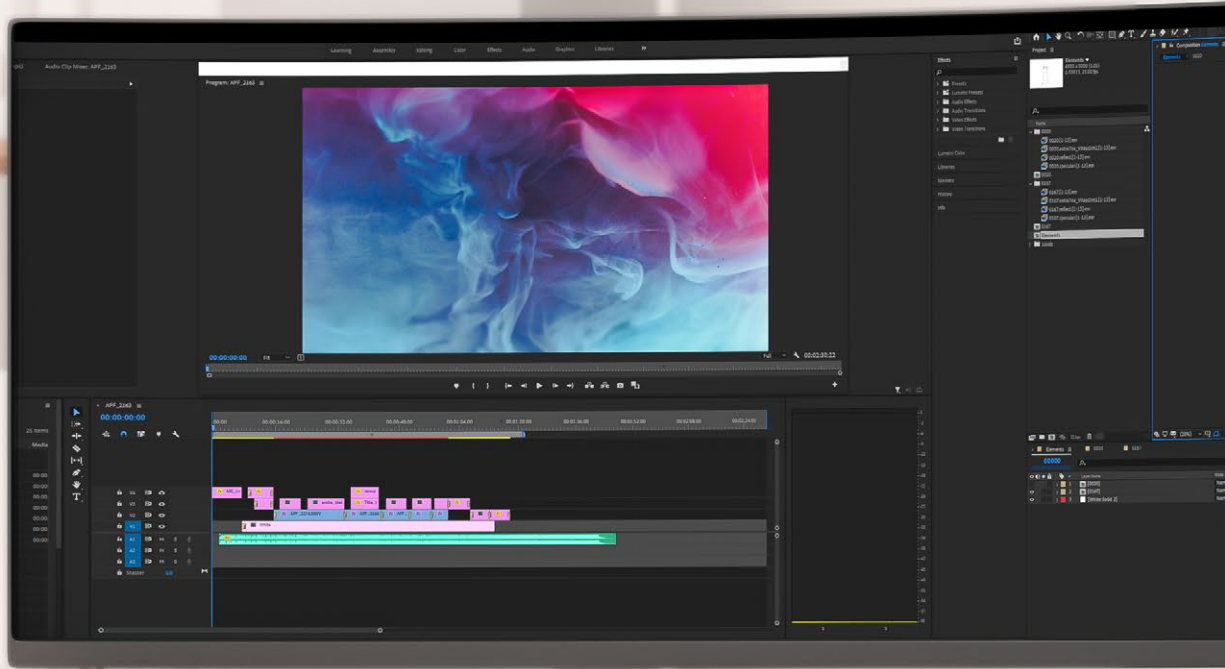



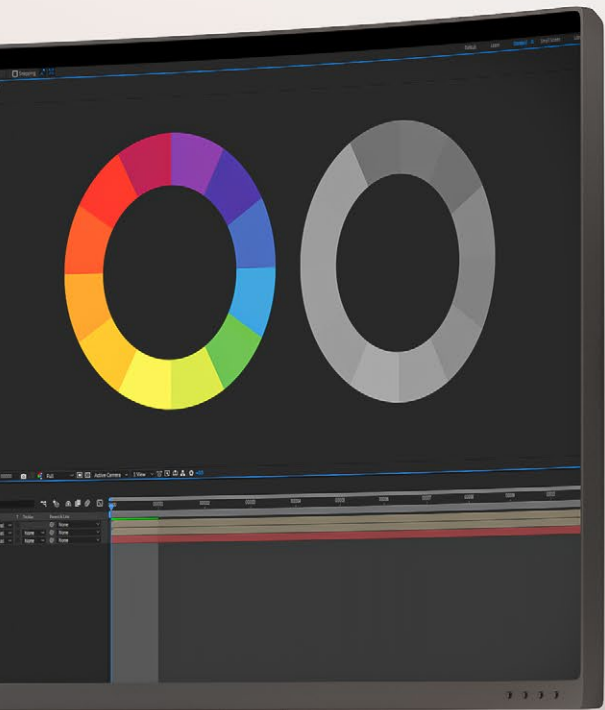

# M VESA GAS LIFT ARM SINGLE

## UNIQUE GAS TECHNOLOGY THAT PROVIDES SMOOTH ADJUSTMENT IN ANY DIRECTION

A triple jointed gas suspended monitor arm, designed by Multibrackets to optimize your productivity and help reducing strain on neck, back and eyes.

These Full Motion Universal Desk Mounts goes beyond simple movements by offering tool less movement and counter balance weight adjustment. The original M VESA Gas Lift Arms are made out of a durable aluminum construction and uses a gas driven suspension technique. Always finding your best view, saving desk space and letting you discover your most productive self, the M VESA Gas Lift Monitor Arms always deliver.

Place your screen where you need it for each project, and then reclaim a space full of opportunities by folding the arm and pushing it aside during a much needed screen break.

Wide	<b>27"-32"</b>
16:9	<b>27"-37"</b>

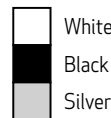
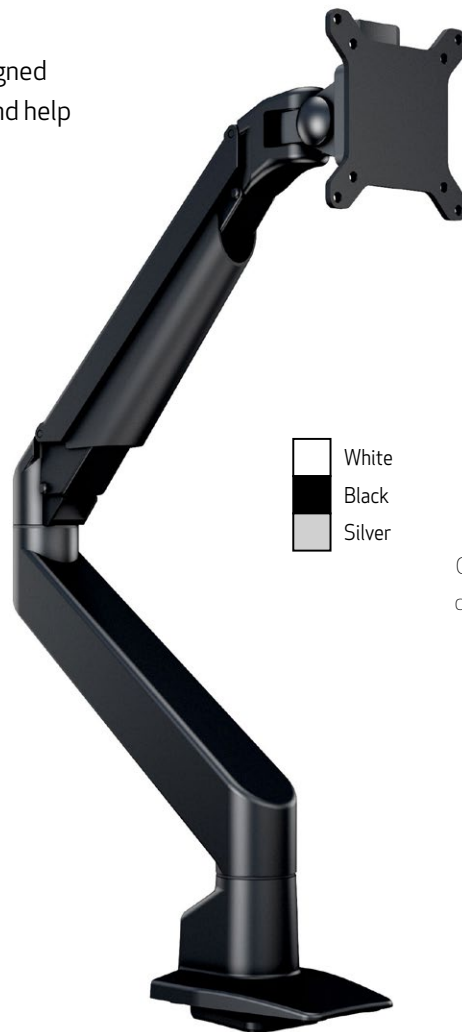

Gas Lift cylinder

### M VESA Gas lift Arm Single

<b>Article No:</b>	7350022737174 - Black 7350022737167 - Silver 7350022737150 - White
<b>For screen size:</b>	15-32"
<b>VESA standard:</b>	75x75, 100x100mm
<b>Colour:</b>	Black / silver / white
<b>Screen weight:</b>	Min. 2 kg - Max. 10 kg
<b>Function:</b>	Gas driven piston
<b>Rotate:</b>	90°
<b>Weight:</b>	3.4 kg
<b>Tilt angle:</b>	+75° to -45°
<b>Turn angle:</b>	+90° to -90°
<b>Warranty:</b>	2 years

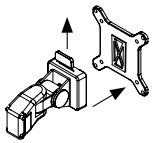

Detachable VESA  
For easy installation

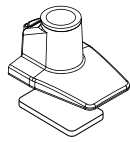

Desk clamp  
(included)

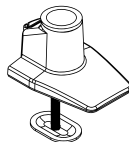

Grommet  
(included)

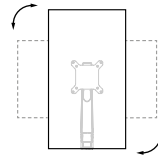

Portrait & landscape  
For a suitable view

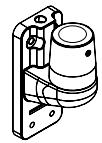

Wall Adapter  
(optional)

## HIGHLIGHTS

- Move your display to a perfect position, improve your daily use and ergonomics
- This arm easily adjusts monitors up to 32" in size
- Clear your desk and enlarge your working area
- We designed this with both mechanics and aesthetics in mind
- Connects your screen to the arm with a snap
- This gas arm is built to last longer than our competitors by passing our 10 000 cycle motion test

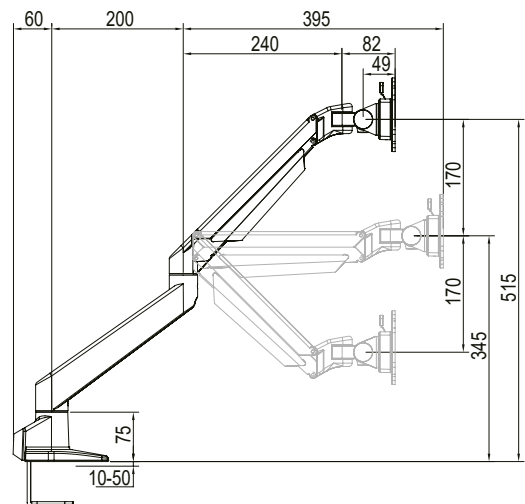

# M VESA GAS LIFT ARM SINGLE XL HD MAKING YOUR WIDESCREEN FLOAT LIKE A FEATHER

Frees up space and allows positioning of your extra large screen for greater productivity.

These Full Motion Universal Desk Mounts goes beyond simple movements by offering tool less movement and counter balance weight adjustment. The original M VESA Gas Lift Arms are made out of a durable aluminum construction and uses a gas driven suspension technique.

Always finding your best view, saving desk space and letting you discover your most productive self, the M VESA Gas Lift Monitor Arms always deliver. Place your screen where you need it for each project, and then reclaim a space full of opportunities by folding the arm and pushing it aside during a much needed screen break.

Wide

27"-37"

16:9

15"-55"

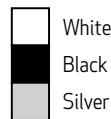

Gas Lift cylinder

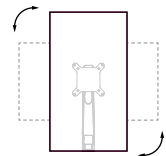

Portrait & landscape  
For a suitable view

## M VESA Gas lift Arm Single XL HD

**Article No:** 7350073737123 - Black  
7350073737130 - Silver  
7350073737147 - White

**For screen size:** 15"-49"

**VESA standard:** 75x75, 100x100, 200x200mm

**Colour:** Black / white / silver

**Screen weight:** Min. 9 kg - Max. 18 kg

**Function:** Gas driven piston

**Rotate:** 90°

**Weight:** 4.4 kg

**Tilt angle:** +75° to -45°

**Turn angle:** +90° to -90°

**Warranty:** 2 years

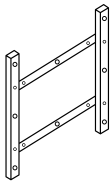

VESA 200x100 & 200x200  
For extra large screens

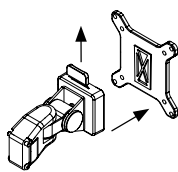

Detachable VESA  
Makes installation easy



Desk clamp & grommet  
(included)



Extension pipe  
(included)

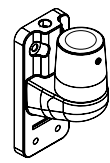

Wall Adapter  
(optional)

## HIGHLIGHTS

- Move your display to a perfect position, improve your daily use and ergonomics
- This arm easily adjusts monitors up to 32" in size
- Clear your desk and enlarge your working area
- We designed this with both mechanics and aesthetics in mind
- Connects your screen to the arm with a snap
- This gas arm is built to last longer than our competitors by passing our 10 000 cycle motion test

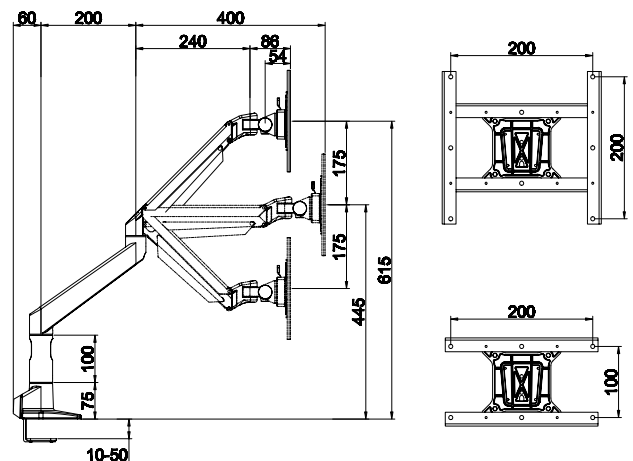





# M VESA DESKMOUNT HD DUAL VERTICAL WIDE 32"-50" STACKING DESKTOP MONITORS INCREASES EFFICIENCY & SAVES SPACE

While desk widths at home often are scarce, ceilings are (so far) staying put. So while you may not have the room to put two or three displays side by side at home, there's almost always ample room to go up, into what is otherwise unused space.

With the new large size widescreen curved monitors hitting the market Multibrackets mounting systems can handle stacked displays as large as twin 50 inch. curved monitors, creating a vast, immersive working canvas .

This is a height adjustable tabletop mount for large size displays with an ultra slim design. With the increasing demand for large size displays and video conference equipment and more focus on collaborative working, we introduced the M Deskmount XL Black.

Easily Mount 37"-55" Monitors or TVs to a Multimedia Table for Use in Conferences, Displays or Presentations. With support of interactive displays and other large size displays our mounts can attach quickly to most any surface and support for video conferences or training, group discussions or presentations in offices, especially in huddle rooms. Rear back hides hardware for a clean look.



## M VESA Deskmount Dual Vertical Wide 32"-50"

<b>Article No:</b>	7350105210556	7350105210563	7350105210570
<b>Colour:</b>	Black	Black	Black
<b>Material:</b>	Aluminum / Steel	Aluminum	Aluminum
<b>Weight:</b>	8 kg	0.5 kg	3.1 kg
<b>Measurements:</b>	800x170x190 mm	210x210x40mm	410x395x40mm
<b>Warranty:</b>	5 years	5 years	5 years
<b>For screen size:</b>	32" - 50"		
<b>Tilt:</b>	Yes -15° - +20°		
<b>Swivel:</b>	Yes ±20°		
<b>Rotate:</b>	Yes 360°		
<b>Installation:</b>	Desk clamp, adjustable 10-60 mm		
<b>Univesal VESA standard:</b>	75x75 100x100 mm		
<b>Max load:</b>	24 kg per screen		
<b>Adjustable height upper screen:</b>	560-790 mm		
<b>Adjustable height lower screen:</b>	185-415mm		
<b>Cable Management:</b>	Yes		



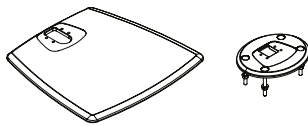
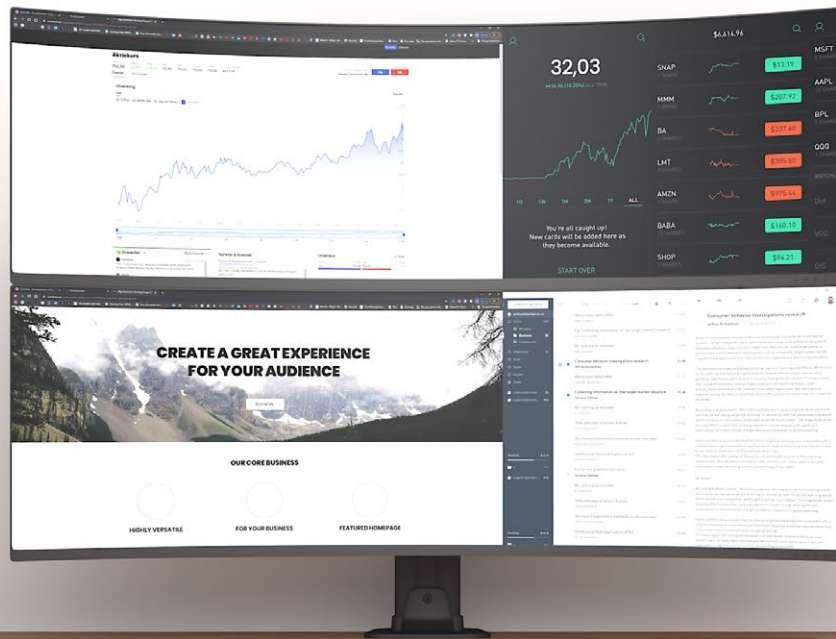

**Exchangeable Base**  
Attach a different base according to your needs

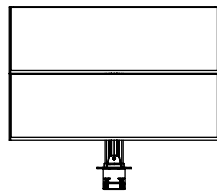

**Large Screens**  
Easily mount two screens on top of each other

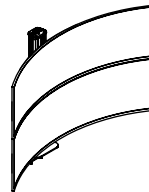

**Curved Screens**  
Specially designed for curved screens

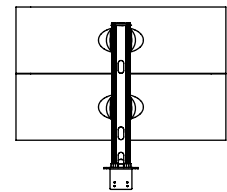

**Cable Management**  
Integrated cable management for clean installation

## HIGHLIGHTS

- A high level designed productline for office use
- Made for the professional user
- Creates maximum ergonomic comfort for displays up to 50"
- Simplified installation and simple after adjustment possibilities
- Plexi based cable management (included)
- Optional through hole installation with Grommet Base



±20° Swivel

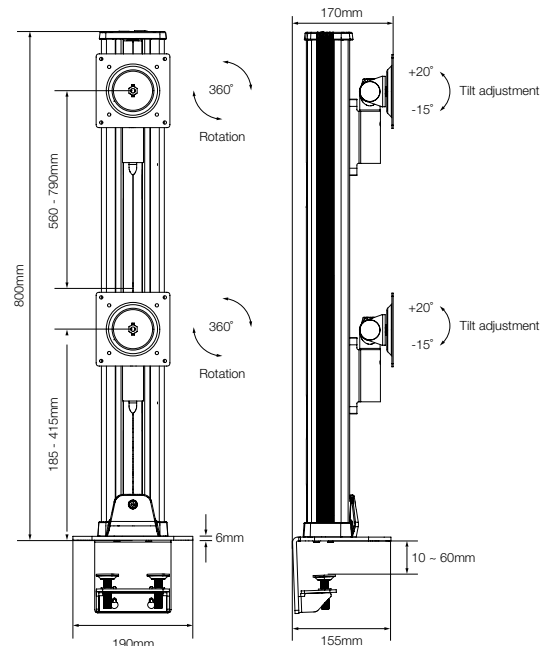

# HEADSET HOLDERS

## MAKING YOU AND YOUR OFFICE DESK STAND OUT!

Brass, copper, stainless steel. A headset stand in solid metal, heavy weight.

Looking for a premium level headset stand for your over ear headphones? Our headset stands have become a classic. Often copied and imitated but never duplicated, today the Standard, 'how an exclusive headset stands should look'. So, keep your on ear headphones secure and above all, neat, hanging freely in the air they are unstressed, ensuring a long lasting, good fit, and all whilst being displayed as if in a boutique store.

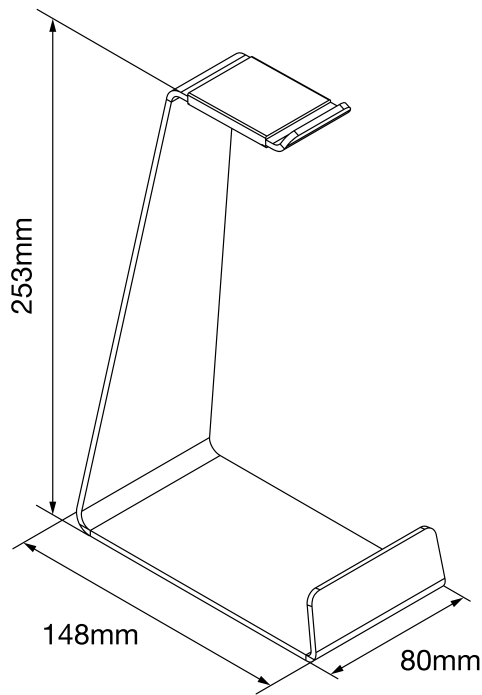

Table Stands



Article No:	7350 073 731 893	7350 073 732 050	7350 073 731 862	7350 073 732 845	7350 073 732 852	7350 073 734 610
<b>Product measurements:</b>	253x148x80mm	253x148x80mm	253x148x80mm	253x148x80mm	253x148x80mm	253x148x80mm
<b>Weight:</b>	272 g	272 g	272 g	272 g	272 g	272 g
<b>Colour:</b>	Black	Silver	White	Brass	Copper	Stainless Steel
<b>Max load:</b>	1 kg	1 kg	1 kg	1 kg	1 kg	1 kg
<b>Gift box measurements:</b>	260x150x80mm	260x150x80mm	260x150x80mm	260x150x80mm	260x150x80mm	260x150x80mm
<b>Warranty:</b>	5 years	5 years	5 years	5 years	5 years	5 years



## HIGHLIGHTS

- Uniquely designed and handmade
- The original universal Headphones stand
- Made out of one piece solid material
- Makes your office desk stand out

Desk



Wall



	7 350 073 731 886	7 350 073 732 043	7 350 073 731 855	7 350 073 731 879	7 350 073 732 036	7 350 073 731 848
<b>Article No:</b>	7 350 073 731 886	7 350 073 732 043	7 350 073 731 855	7 350 073 731 879	7 350 073 732 036	7 350 073 731 848
<b>Product measurements:</b>	112x56x40mm	112x56x40mm	112x56x40mm	112x56x40mm	112x56x40mm	112x56x40mm
<b>Weight:</b>	52 g	52 g	52 g	37 g	37 g	37 g
<b>Colour:</b>	Black	Silver	White	Black	Silver	White
<b>Max load:</b>	1 kg	1 kg	1 kg	1 kg	1 kg	1 kg
<b>Gift box measurements:</b>	120x60x45mm	120x60x45mm	120x60x45mm	120x60x45mm	120x60x45mm	120x60x45mm
<b>Warranty:</b>	5 years	5 years	5 years	5 years	5 years	5 years

# CABLE SOCKS ELEGANT RESISTANCE FOR DELICATE CABLES

Versatile, with flexible properties Cable Socks gives abrasion resistance for delicate cables.

Leaving delicate cables exposed to the outside elements puts them at risk of costly abrasive damage and UV degradation. Adding Multibrackets cable sock solutions to cables in high traffic or high friction areas will help extend cable life and save you money down the road. Unlike traditional braided sleeving or wire loom, these cable socks install easily with no special tools or endless sliding. Our unique colour options also allow colour coding and easy identification of cable infrastructure. A good choice for AV cables, computer cables (inside and out), server halls, datacentres optical cables (5mm version), hospitals, hotel rooms and anywhere else one might need high quality cable socks. Our Cable Socks are also fire retardant.

## HIGHLIGHTS

- Expands easily to ensure complete coverage and protection.
- Offers general protection from abrasion, chemicals and temperature for optimal protection.
- Available in various sizes and colors.
- Designed to adjust and expand to irregular shapes.
- Keeps its flexibility under a wide range of temperatures and over time.

## 25m rolls!



### M Universal Cable Socks Self Wrapping

<b>Material:</b>	Polyester
<b>Self wrapping:</b>	Yes
<b>Sock length:</b>	25m
<b>Working temp. :</b>	-50°C-+ 150°C
<b>Melting point:</b>	240±10°C
<b>Flammability:</b>	8s6853 lb UL94 V-0 FMVSS 302
<b>Monofilament diameter:</b>	0.25mm
<b>Safety:</b>	Fire retardant material
<b>Certificate:</b>	RoHS
<b>Warranty:</b>	5 years
<b>Weight:</b>	Depending on size

#### Wear-resisting level:

ISO6722, Load 7N, Number of scratches >3000 times, high wear resistance.

#### Application:

It is widely used in electrical wiring, cables, wiring harness and hoses for high-speed trains, cars, automation equipment, instruments, and especially for irregularly wiring harness.

































<b>Model:</b>	M Cable Sock Heat Cutter
<b>Article No:</b>	7 350 022 732 926
<b>Colour:</b>	Light Blue
<b>Warranty:</b>	1 year

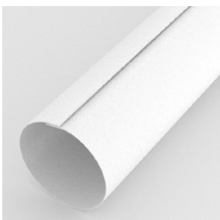

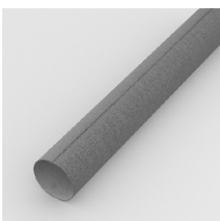
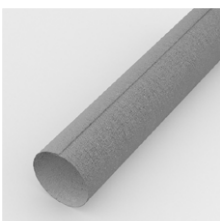
<b>Model:</b>	M Cable Sock Quicktool
<b>Article No:</b>	7 350 073 734 689
<b>Colour:</b>	Blue
<b>Warranty:</b>	1 year

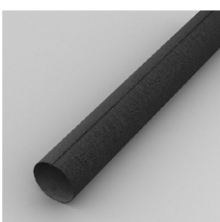
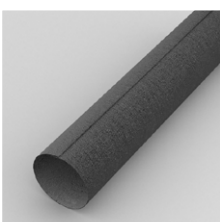

- Constructed from tightly woven polyester material.
- Provides easy installation on already existing applications simply unwrap the cable sock and apply directly to your cable or product.
- Highly versatile with flexible properties, excellent for office/commercial/ industrial uses.

Diameter:	5mm - 9mm	10mm - 14mm	19mm - 30mm	25mm - 35mm	40mm - 50mm
<i>YELLOW</i>	 7350 073 734 382	 7350 073 734 429	 7350 073 734 467	 7350 073 734 504	 7350 073 734 542
<i>ORANGE</i>	 7350 073 734 399	 7350 073 734 436	 7350 073 734 474	 7350 073 734 511	 7350 073 734 559
<i>RED</i>	 7350 073 734 412	 7350 073 734 450	 7350 073 734 498	 7350 073 734 535	 7350 073 734 573
<i>BLUE</i>	 7350 073 734 405	 7350 073 734 443	 7350 073 734 481	 7350 073 734 528	 7350 073 734 566
<i>WHITE</i>	 7350 073 733 194	 7350 073 733 224	 7350 022 734 203	 7350 073 732 777	 7350 073 732 807
<i>GREY</i>	 7350 073 733 200	 7350 073 733 231	 7350 022 734 180	 7350 073 732 784	 7350 073 732 814
<i>BLACK</i>	 7350 073 733 217	 7350 073 733 248	 7350 022 734 197	 7350 073 732 791	 7350 073 732 821





***“Everything starts with you.***

***For us to create great products it always begins with putting you the user at the heart of everything we do.”***

### **Mission**

We are on a mission to create products that are simple to install and use, that excites and solves our clients daily needs - everyday, all year around. Based in Stockholm, Sweden we design, develop and market AV Equipment. But we do it our way. Armed with a genuine passion for new technology and user centric innovation, we take a product and give it a little bit of Multibrackets magic!

### **About us**

Founded in year 2000 we are a family owned business and represented in over 30 countries. Today we are considered one of the leaders in the rapidly changing environment of digital signage technology – together with our distributors we are providing hardware and services to enable the full value from idea to a ready product. With one of the most comprehensive product lines in EU we supply Audio Visual Equipment for every need. Multibrackets reputation for innovative products is well known.

### **Become a partner**

Stay ahead of your competition – Let us help you become a partner. Simply send us an email on [support@multibrackets.com](mailto:support@multibrackets.com) or go to our webpage <https://products.multibrackets.com/en/contact> for a contact with us at Multibrackets and we will help you with a distributor's contact. We look forward to your email.

### **Contact details**

Multibrackets Europe AB  
Döbelnsgatan 21, 11th floor  
SE-111 40 Stockholm  
SWEDEN

Reach us on email [support@multibrackets.com](mailto:support@multibrackets.com) or phone +46 (0)8 - 615 04 00

### **Sustainability**

At Multibrackets we see sustainability like a journey. Being in the AV business means we have a responsibility to take care of the environment and everybody who plays a part in making our products. We are working hard to design sustainable products, minimize our impact on the environment, improve our sourcing and create a great workplace for our employees. Find out more about what we are doing and what we've already achieved on our web.

### **Copyright**

This catalogue is protected by copyright laws. The graphic design, content, and images in this catalogue may not be reproduced, published displayed, or reproduced in any way, in whole or in part. This catalogue is considered the intellectual property of Multibrackets Europe AB, and we respectfully ask that you not copy, transmit, distribute, or create a derivative work based upon the content and materials of this catalogue. The content is also subject to the copyright laws of EU and the US (Act of 1976, Title 17 of the United States Code) and may not be copied for use in your publications or newsletters without prior written consent of Multibrackets Europe AB. If you are a customer of Multibrackets Europe AB and would like permission to use one of our articles in your company publication, please email and we would be happy to consider giving you permission to do so, as long as you would be willing to credit your source (Multibrackets Europe AB).

### **We reserve ourselves for printing errors**

Printing errors. While we strive to display all our information as correct as possible, there sometimes occurs misprinting's and faulty information in catalogues. If this happens, and it should affect in any way the forms of, for example faulty product information, or the alike, we will inform you as soon as we notice, and amend it. Please note that we reserve ourselves the right to cancel any order that has been sold presented with a misprinted information. Editing, deleting, or modification of this catalogue: We reserve the right, for any reason, to edit this catalogue. That means, without advance notice, we may suspend, discontinue, edit, or delete current information, products, services, or any other content appearing in this catalogue.

Again, Welcome to Multibrackets Europe, one of the leading manufacturers of Audio Visual Equipment in Europe.



**Multibrackets Europe AB**



Official distributor

MAJAR Group of Companies – Matzaridis Bros S.A.  
I. Tsalouchidi 16 - 20, Business Center, 54248, Thessaloniki, Greece

Tel.: +30 2310 928 851  
[www.majar.gr](http://www.majar.gr) - [info@majar.gr](mailto:info@majar.gr)

